

SINGER
45K57,75,76,87

Supersedes K5628

HISTORICAL COPY

DO NOT REMOVE
ILLUSTRATED LIST OF PARTS

FOR

Nos. 45K57, 45K75, 45K76
and 45K87 MACHINES

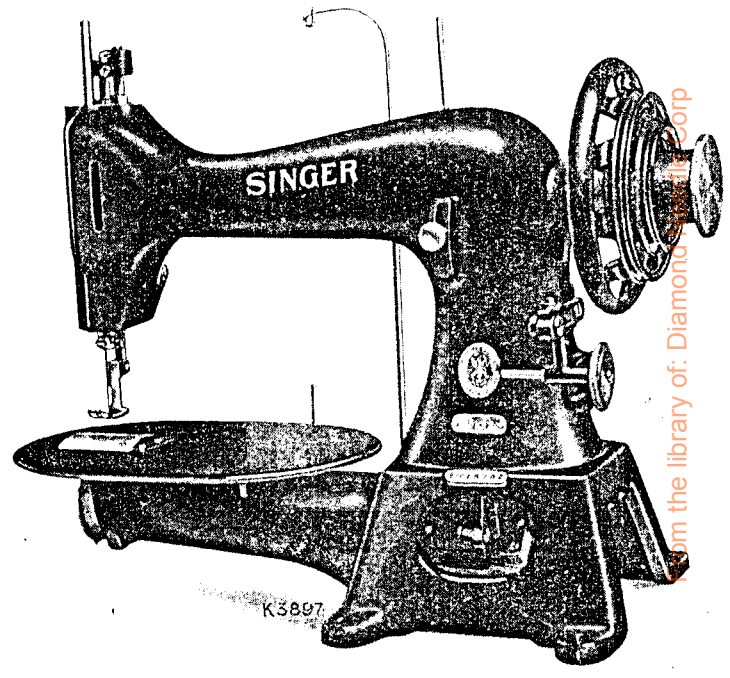

45K57 Machine

**A Trade Mark of
THE SINGER MANUFACTURING COMPANY

from the library of: Diamond Drill Corp

RECEIVED
NOV 1951
COST DEPT

COPIES RECEIVED

Handwritten notes and signatures, including 'Kohl' and 'W. H. ...'

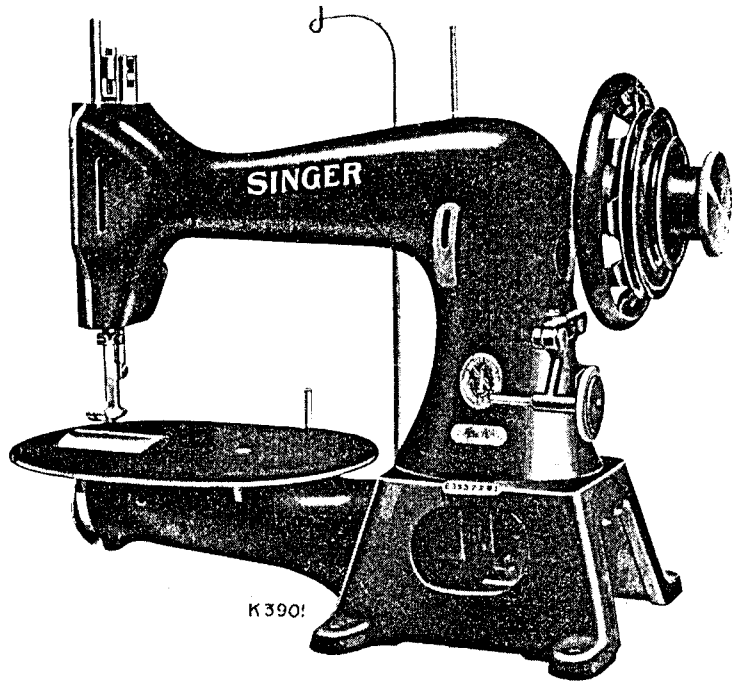

K390!

45K76 Machine

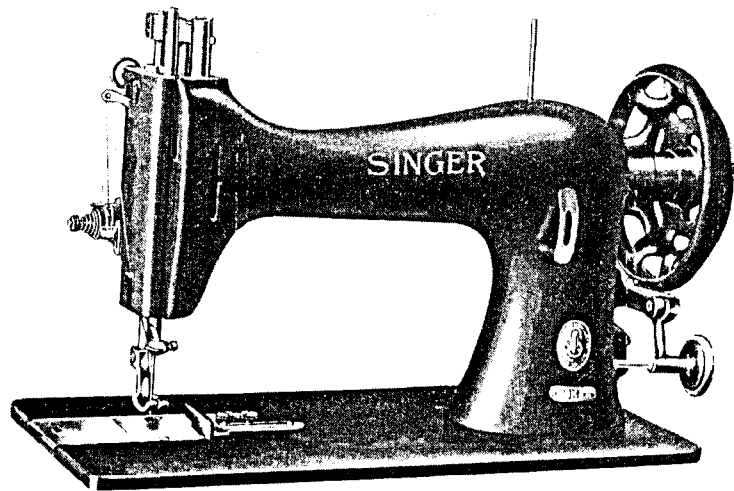

45K87 Machine

K1562

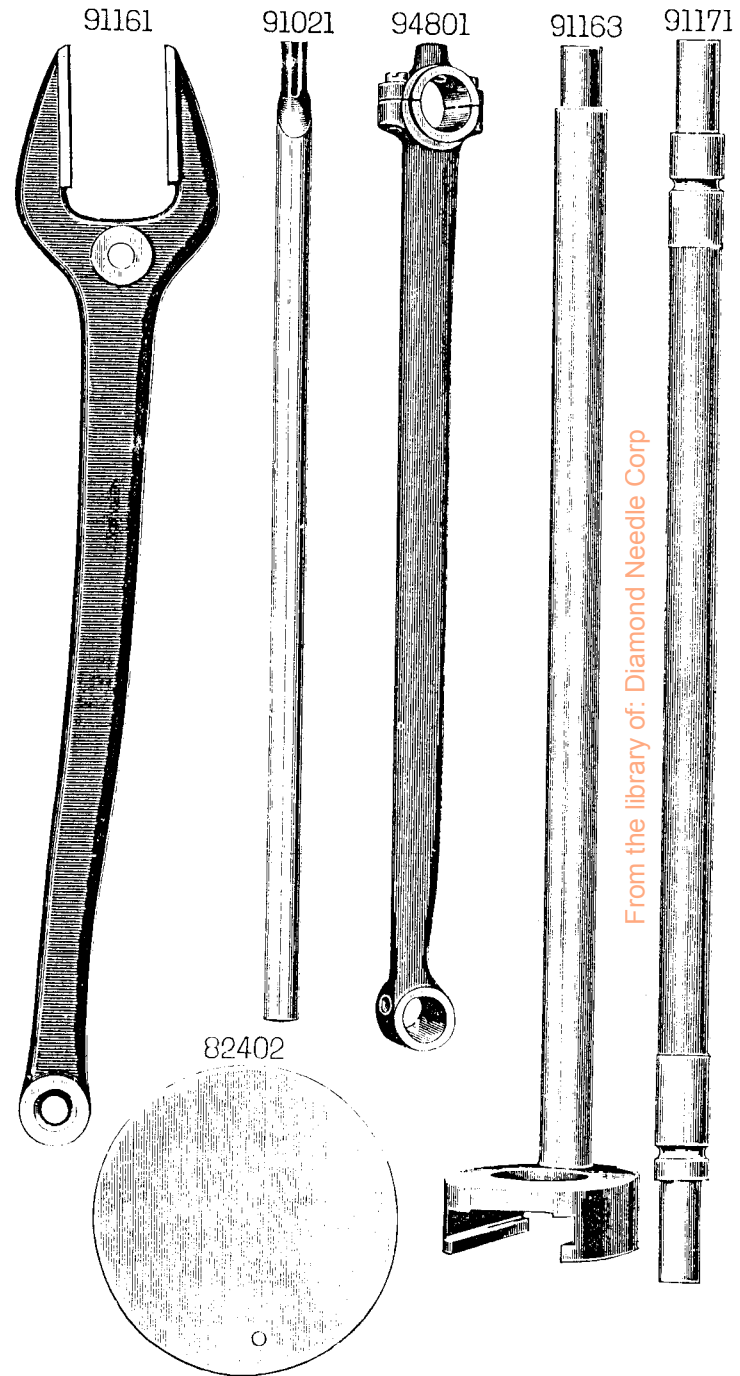

From the library of: Diamond Needle Corp

91233

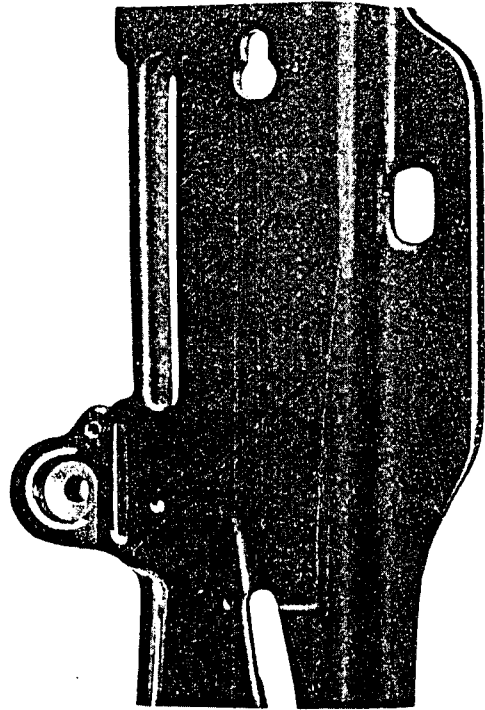

98664



91028



91714

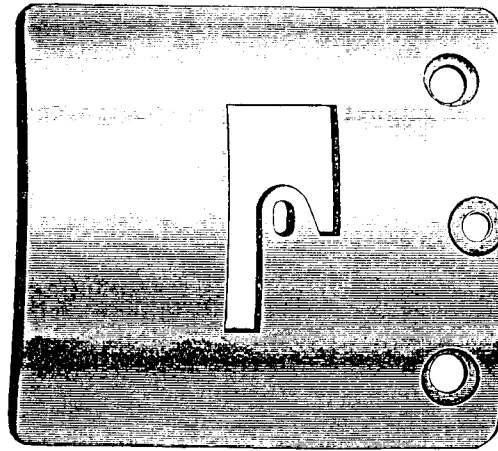

82499

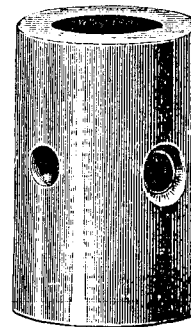

82414

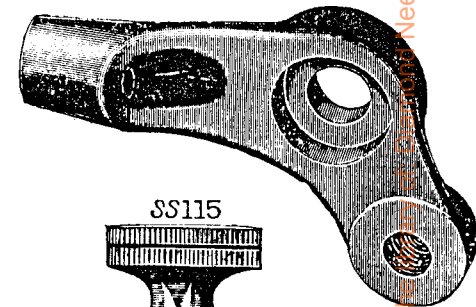

SS115

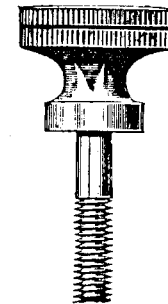

From Needle Corp

91315

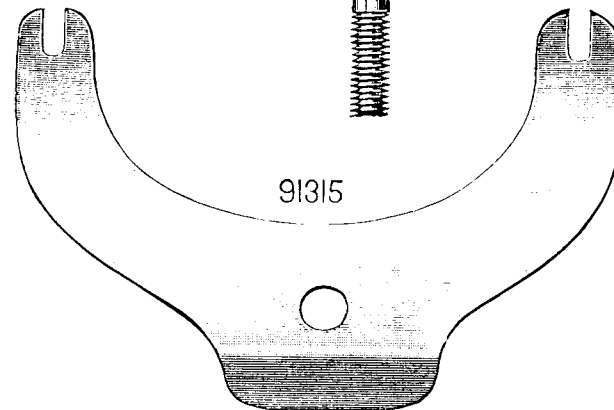

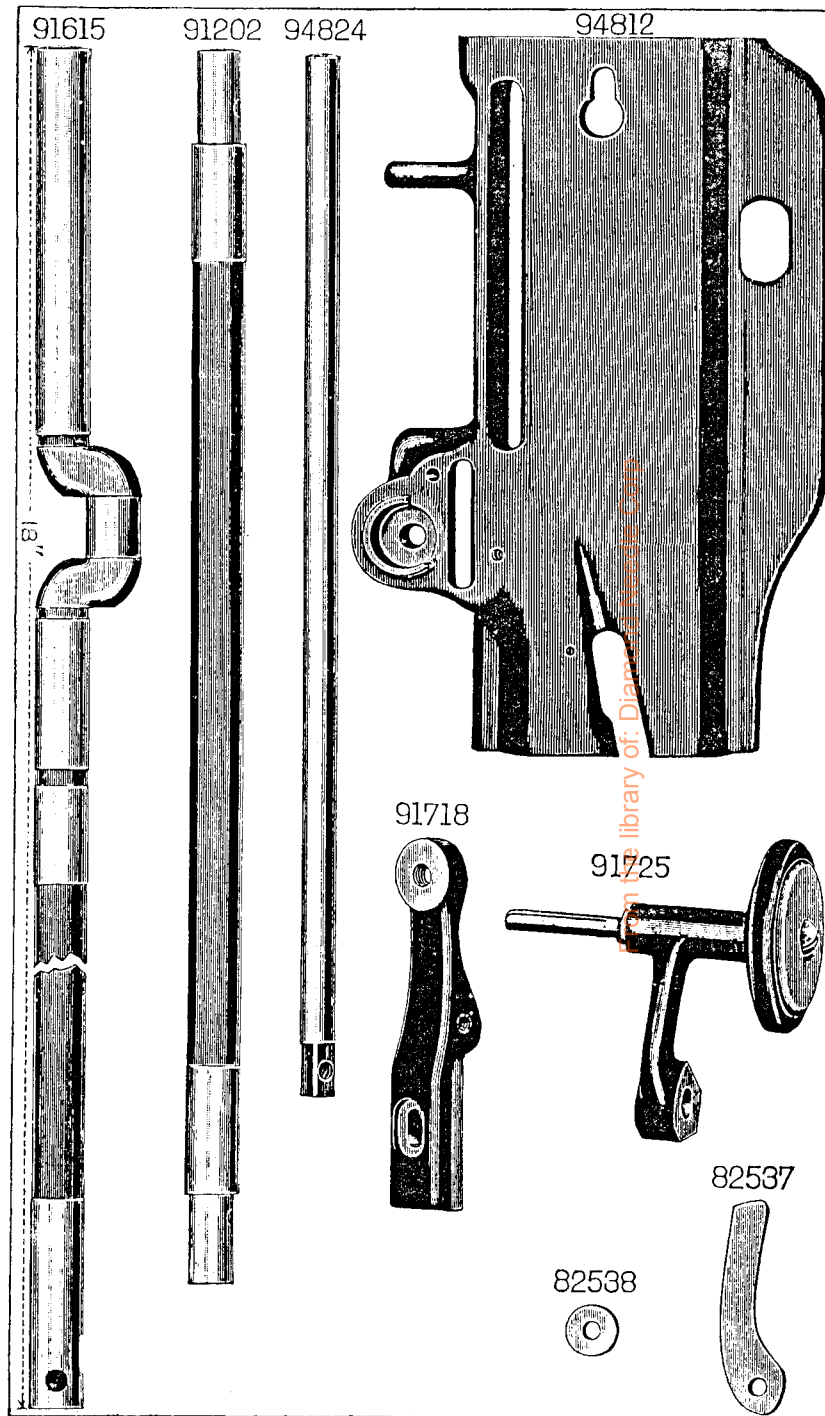
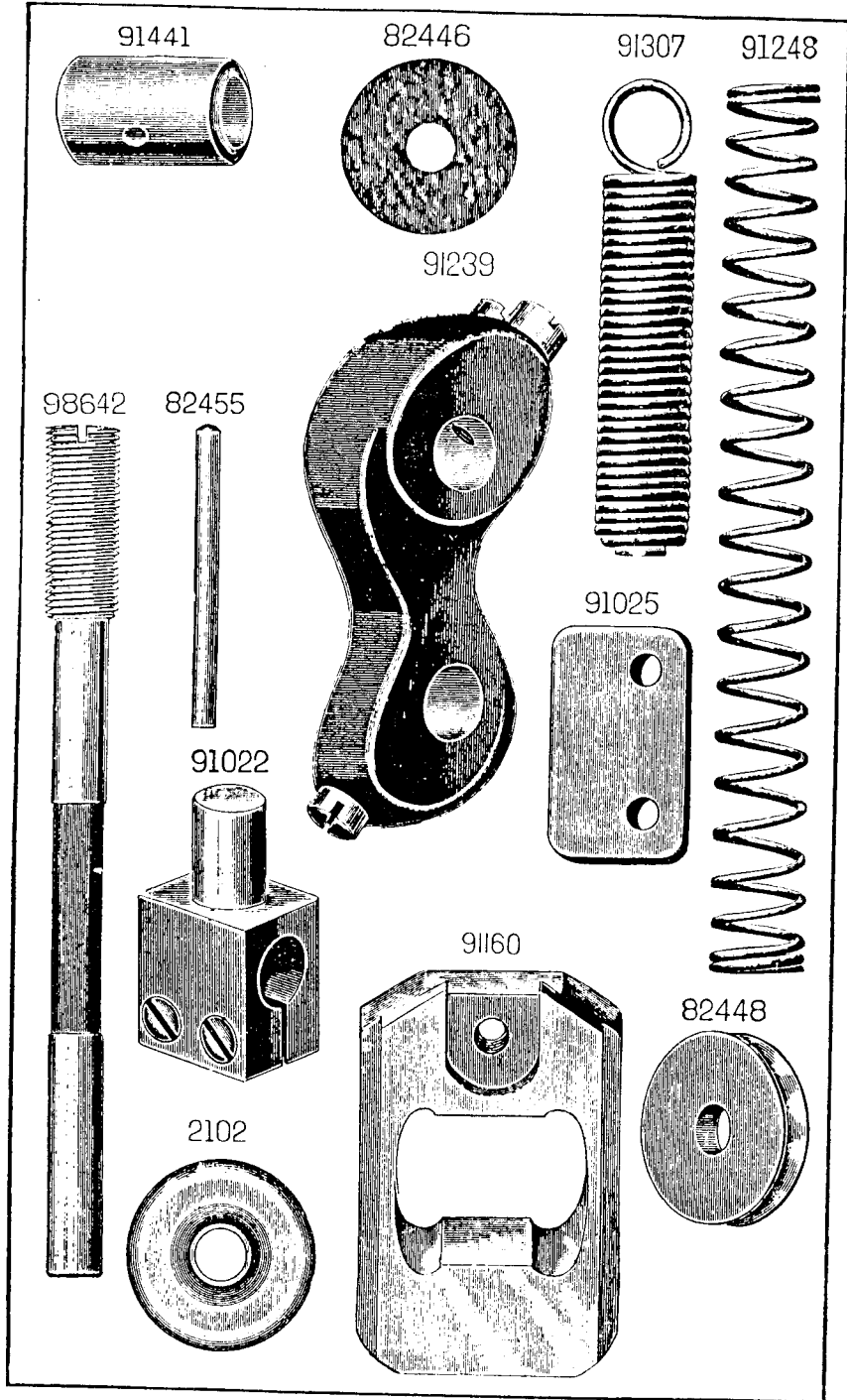

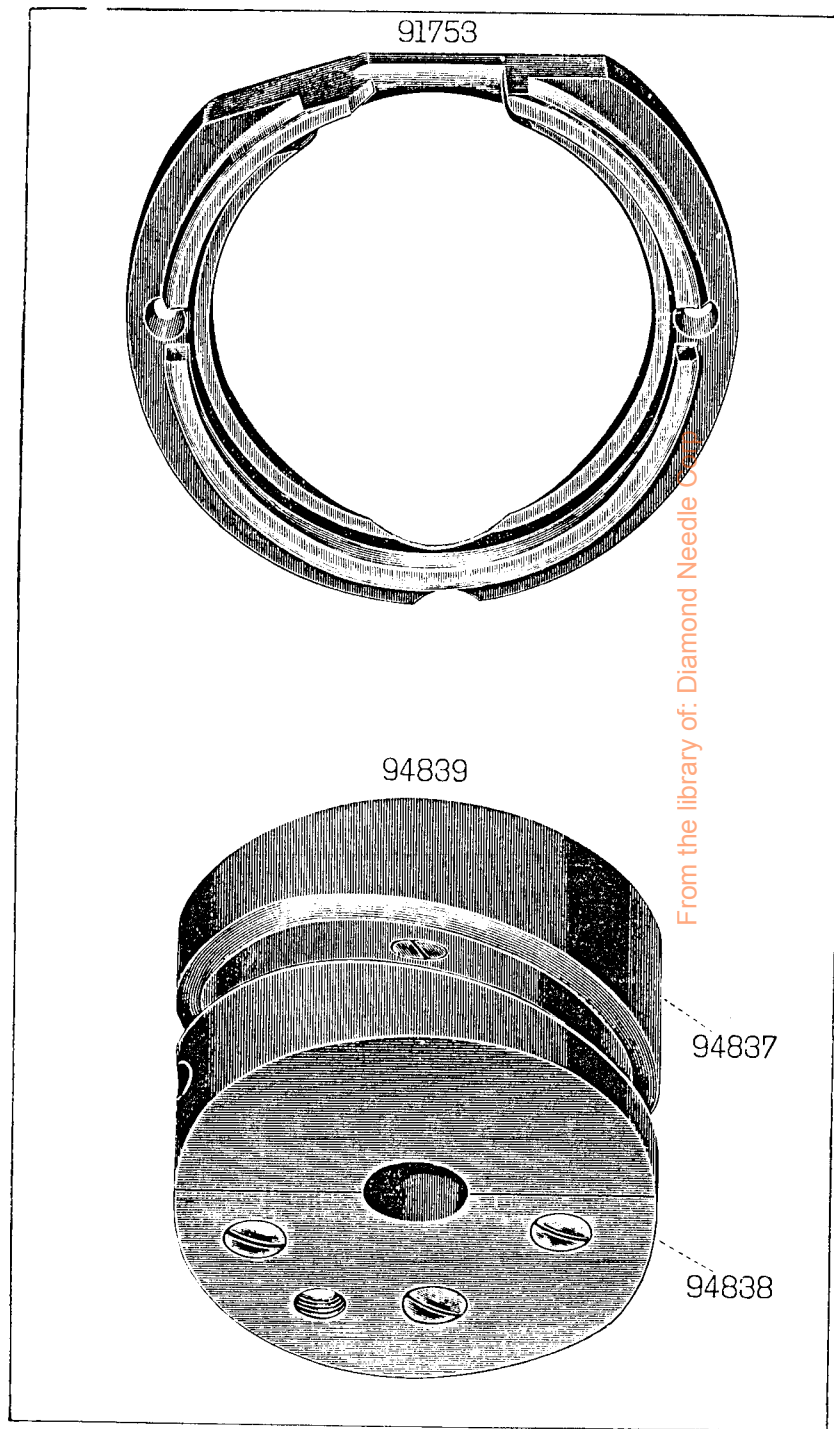
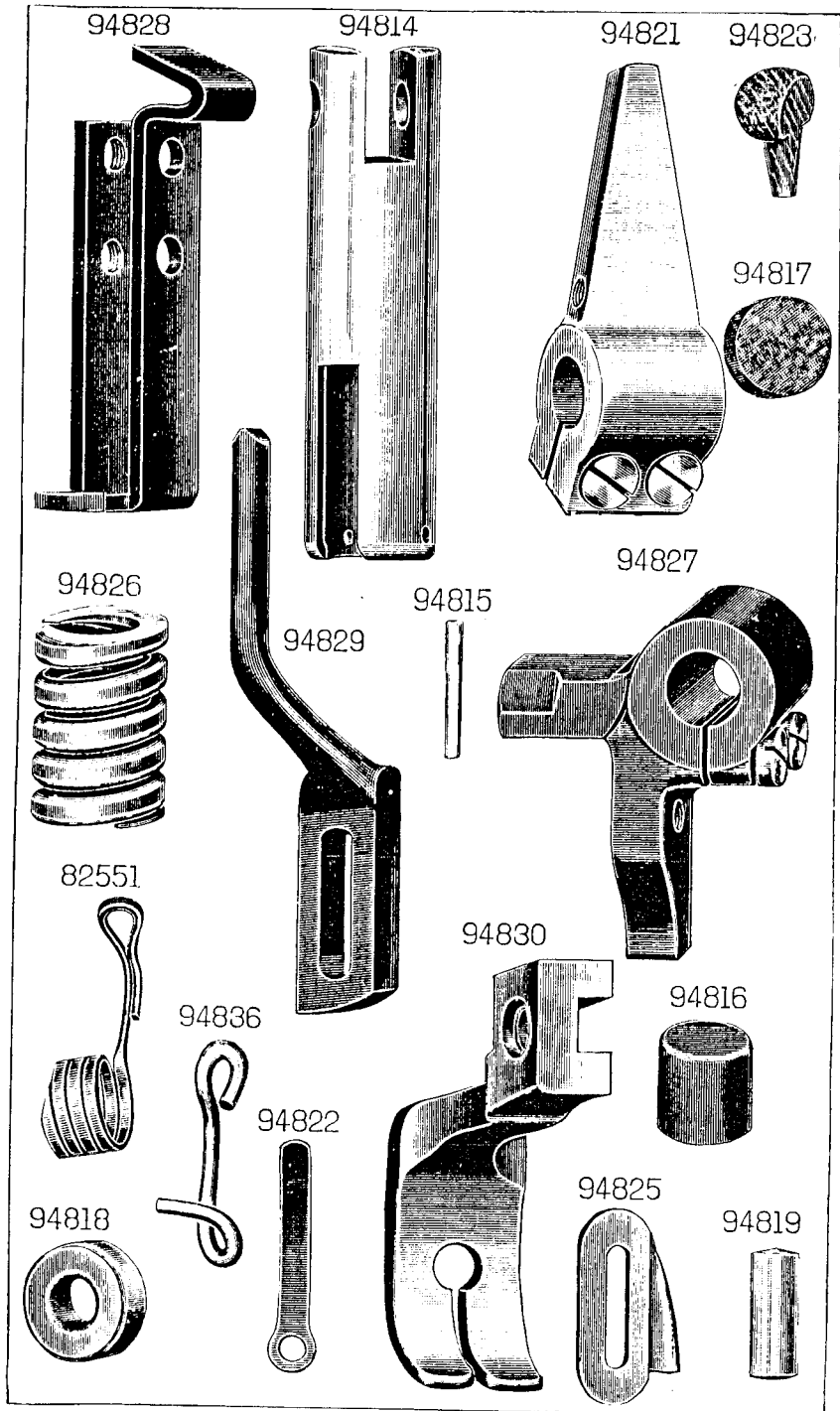

94840

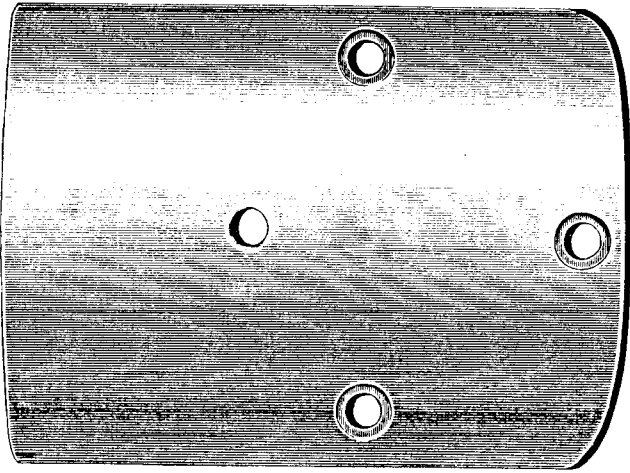

91153

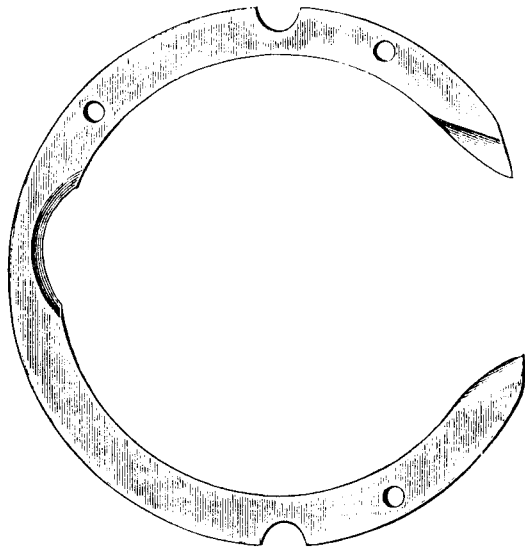

SS425

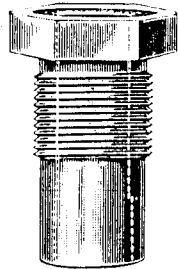

82549

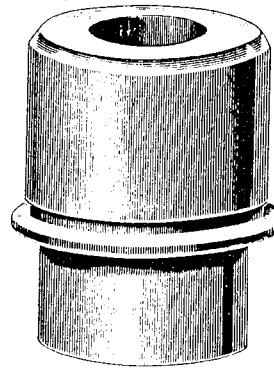

91652

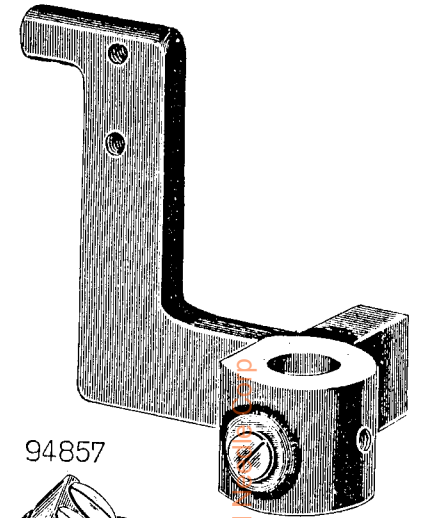

SS517

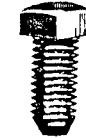

98674

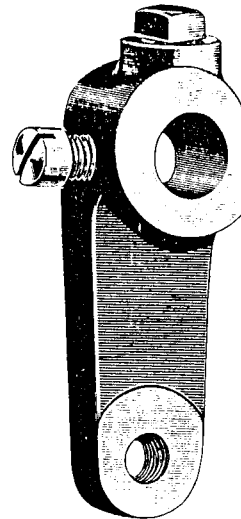

94857

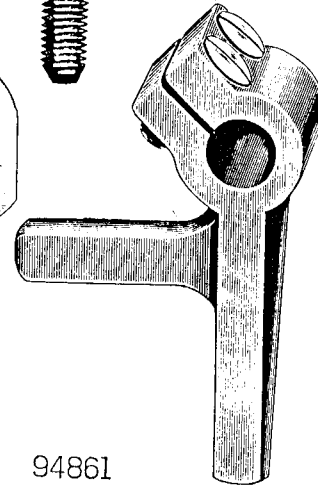

94860

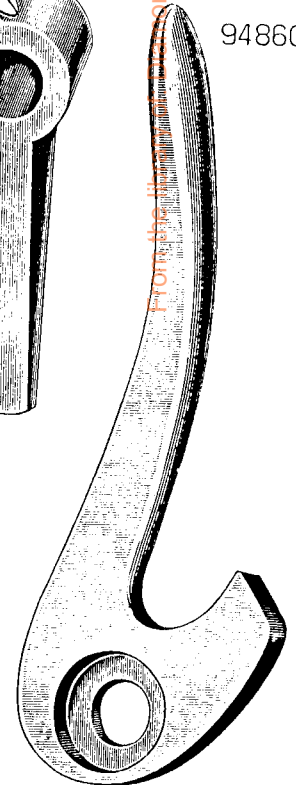

94861

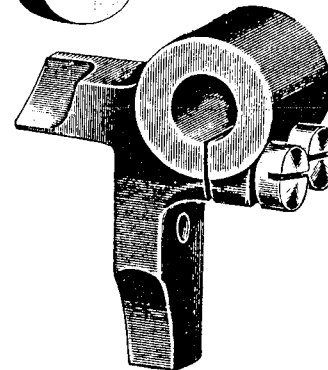

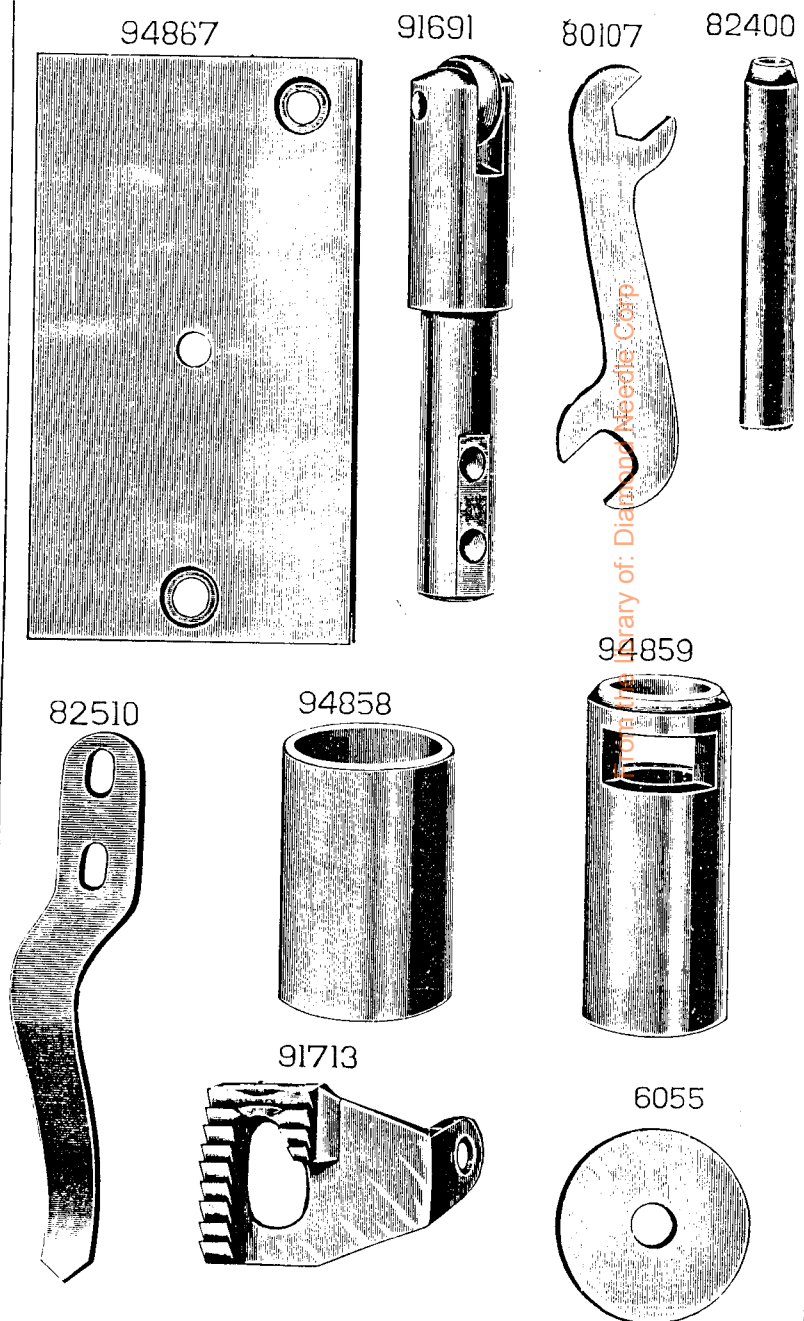
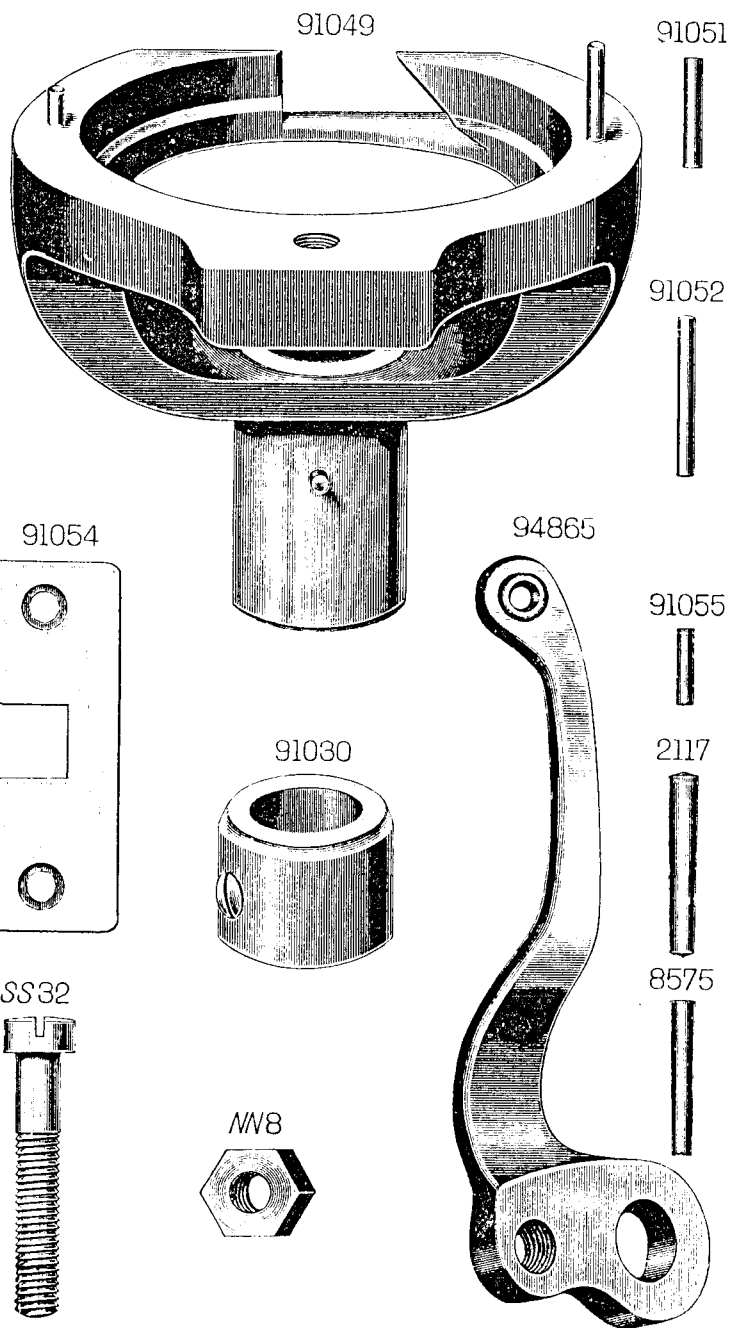

94854

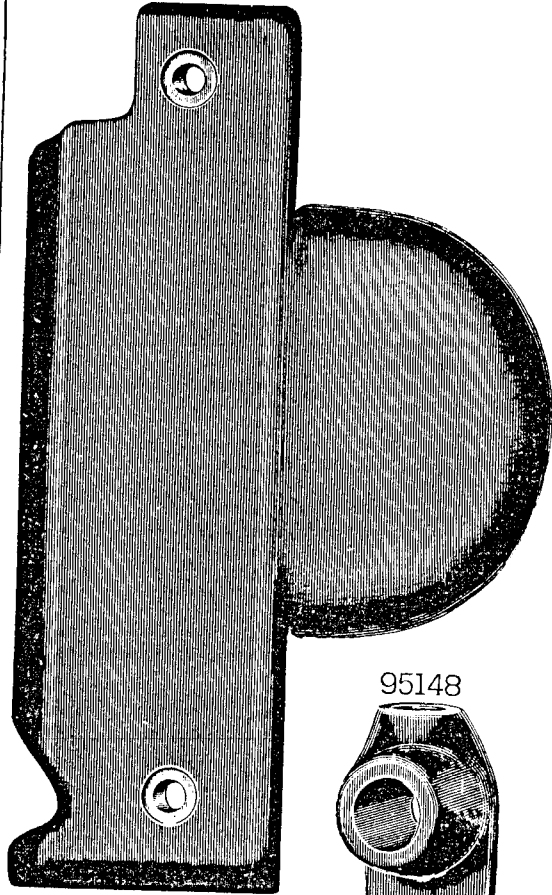

95149



95148

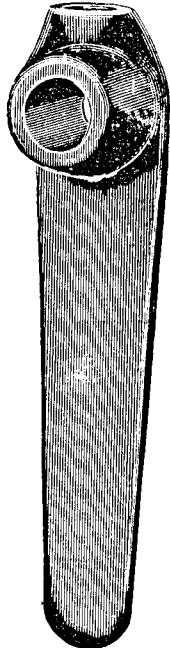

95150



7958 91298

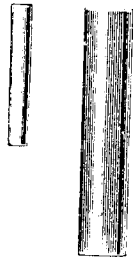

91306

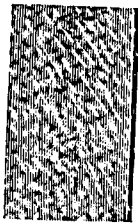

91166



91057

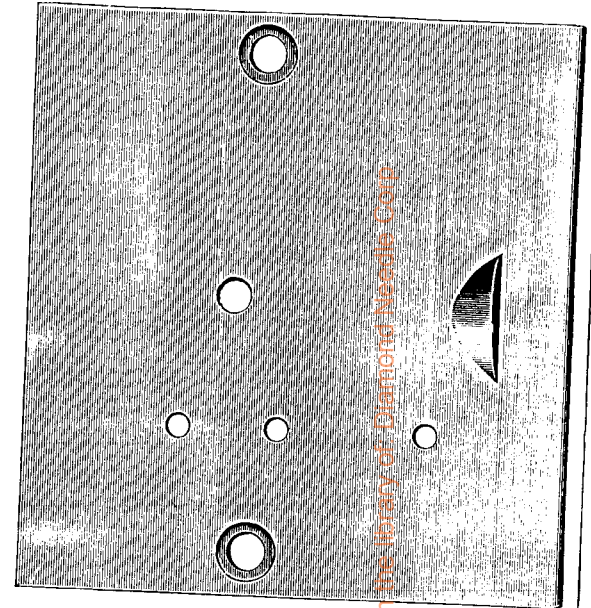

From the Inventory of the Manhattan Project

91059

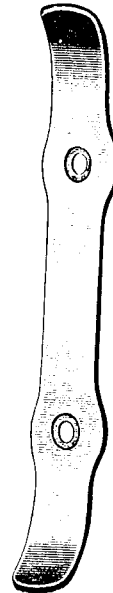

91058

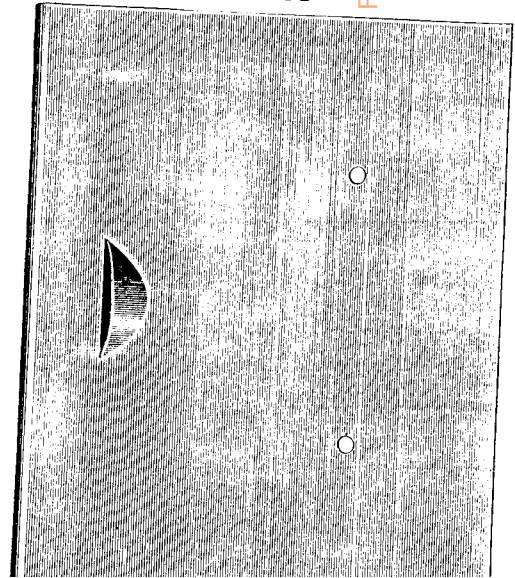

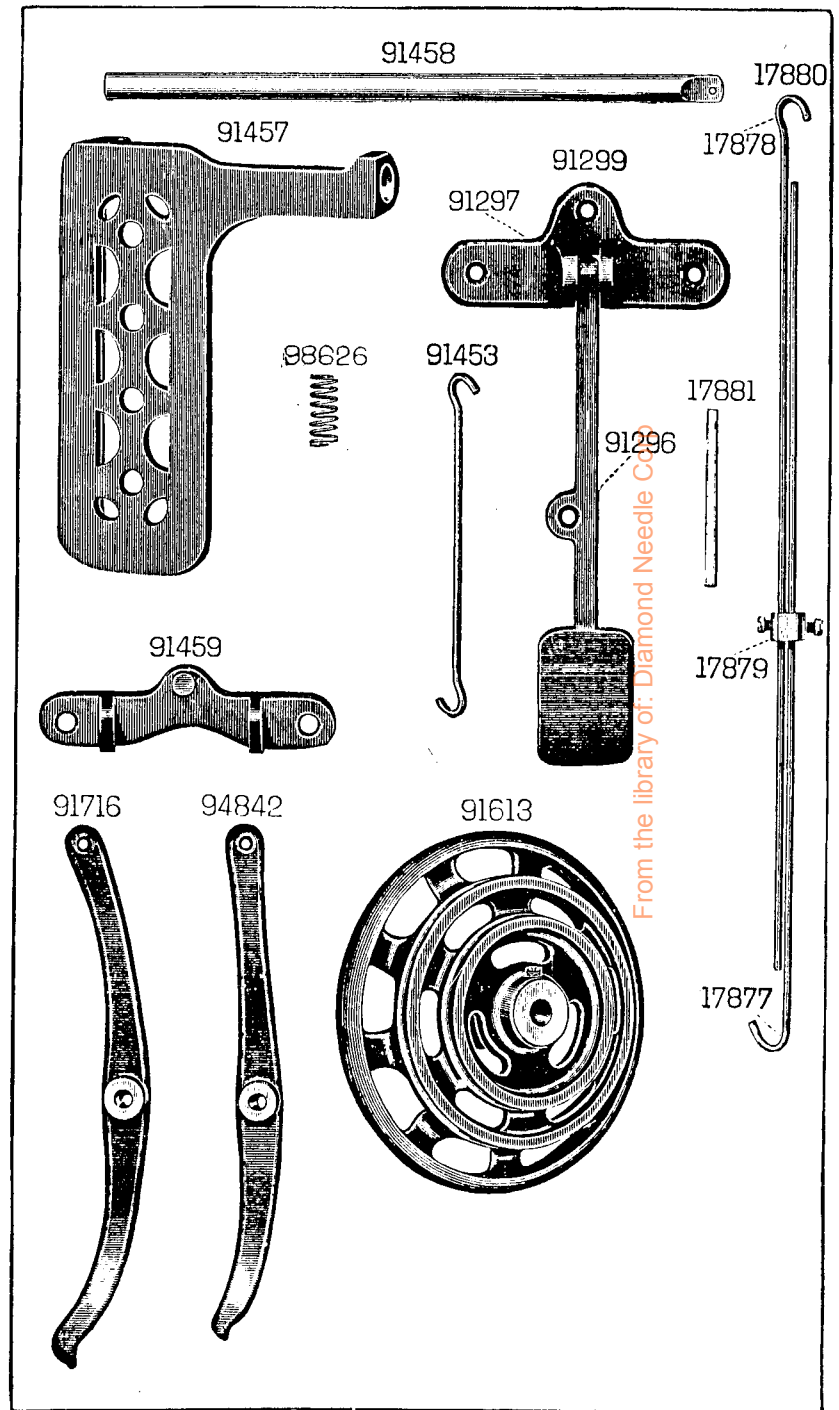
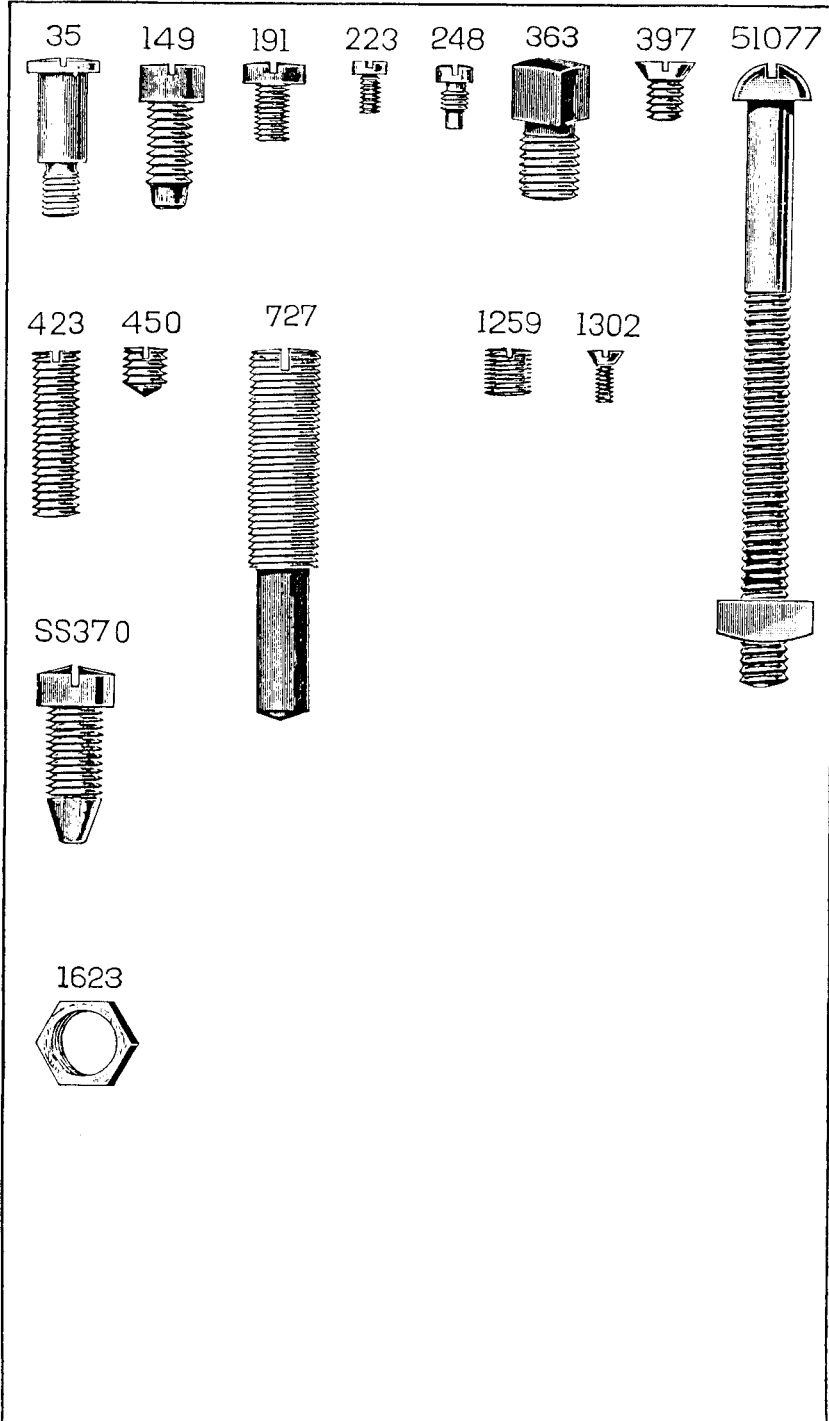

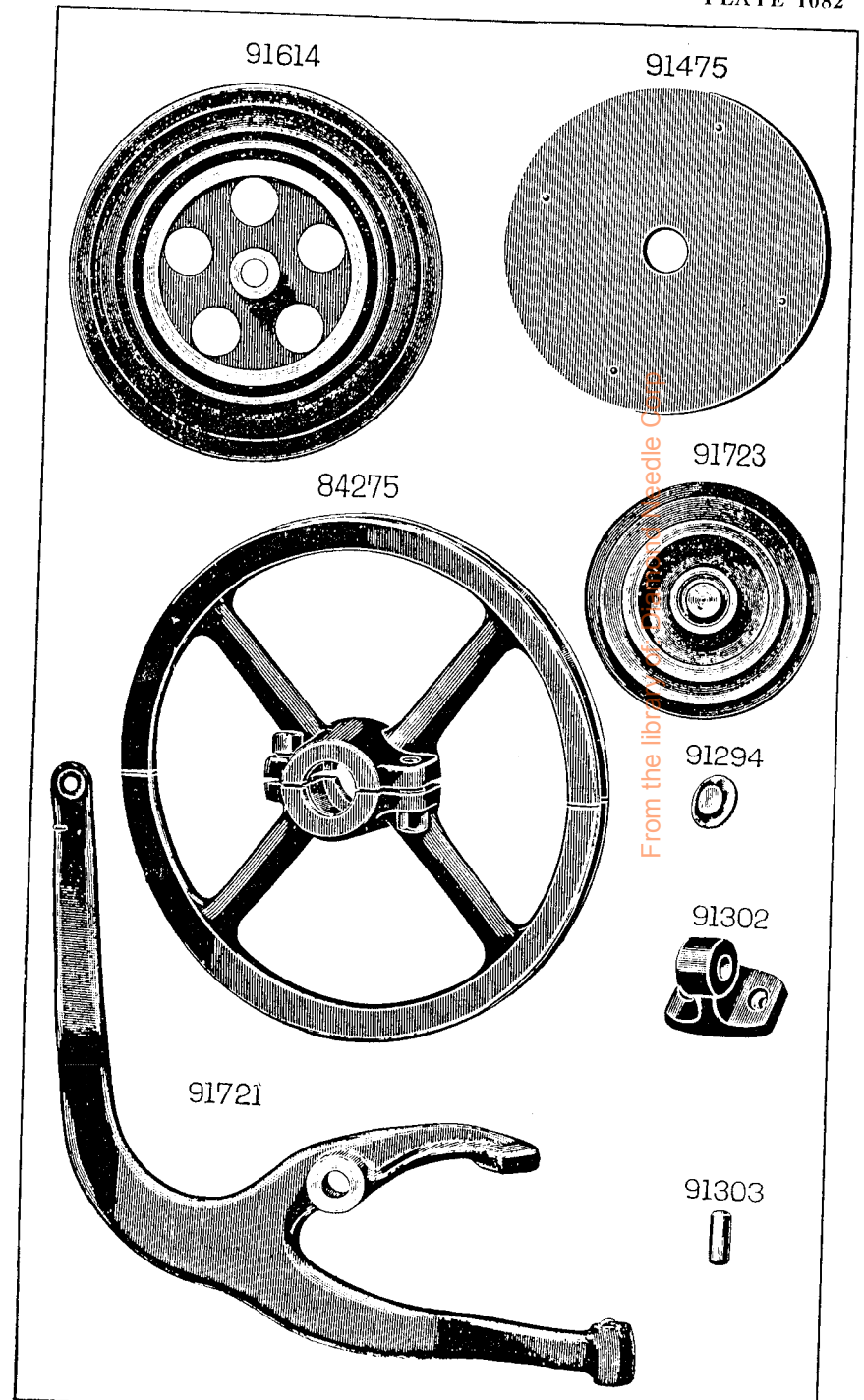
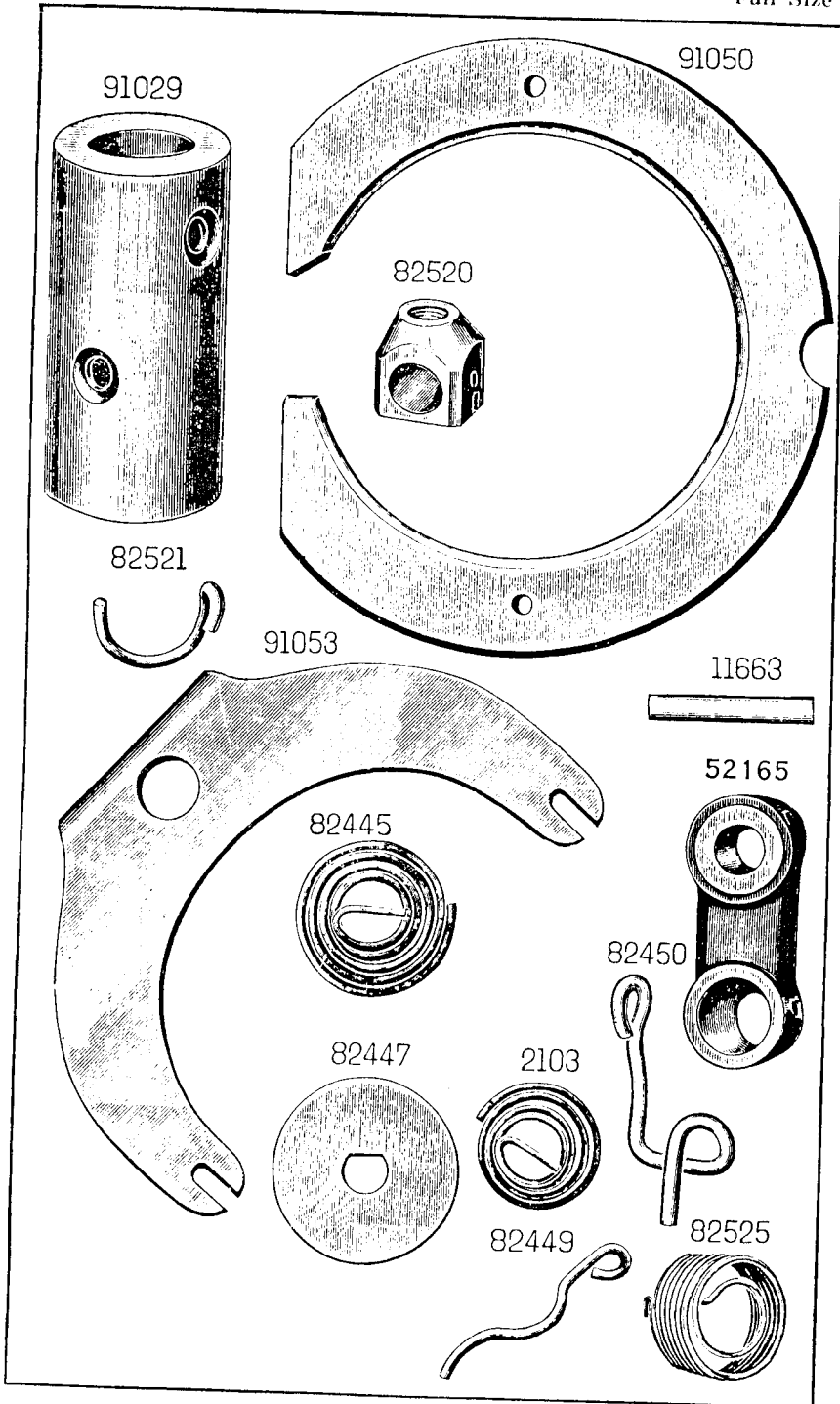

From the library of the Needle Case

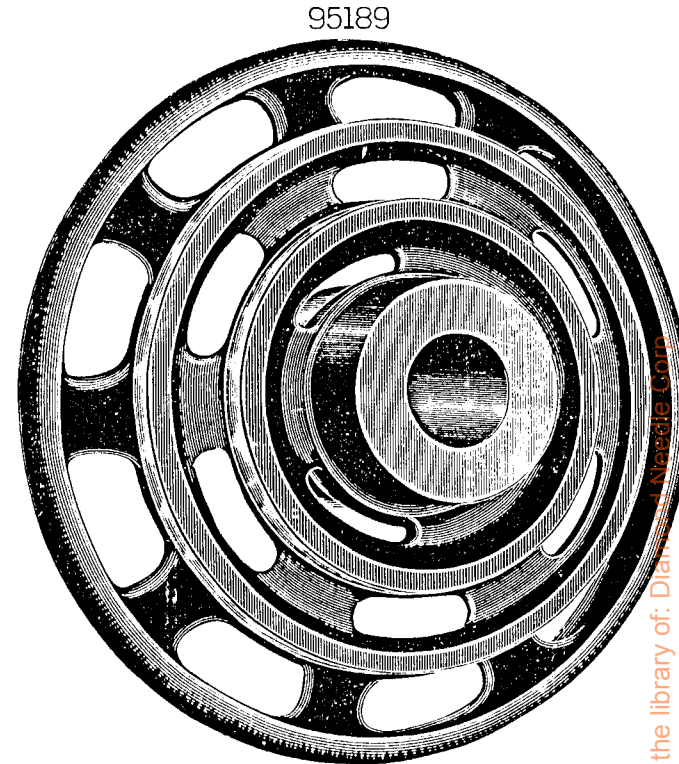
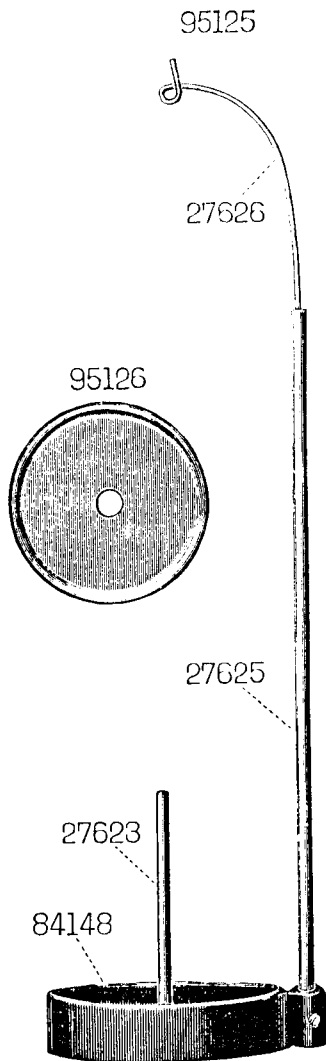

SS463

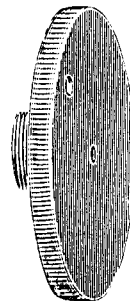

95146

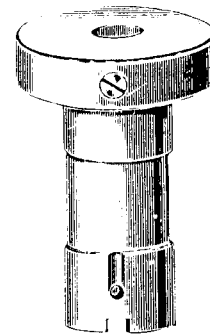

95145

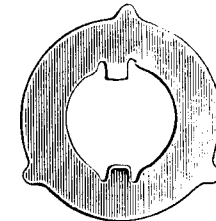

from the library of: Dial.com

95141

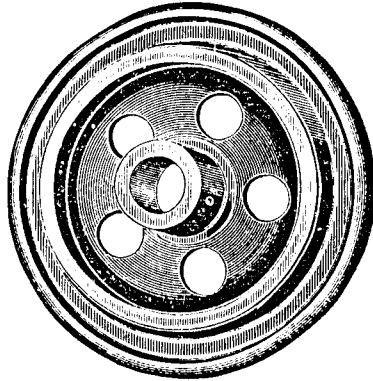

95147

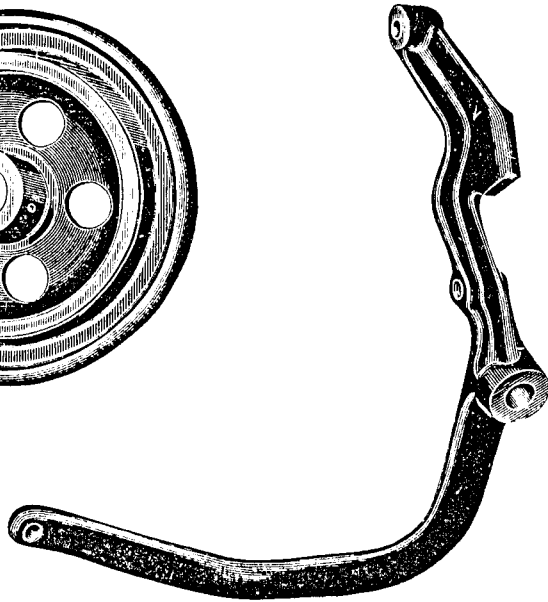

95142

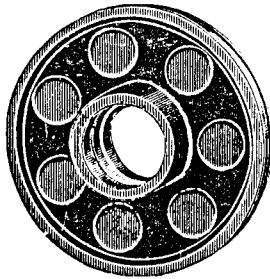

98643

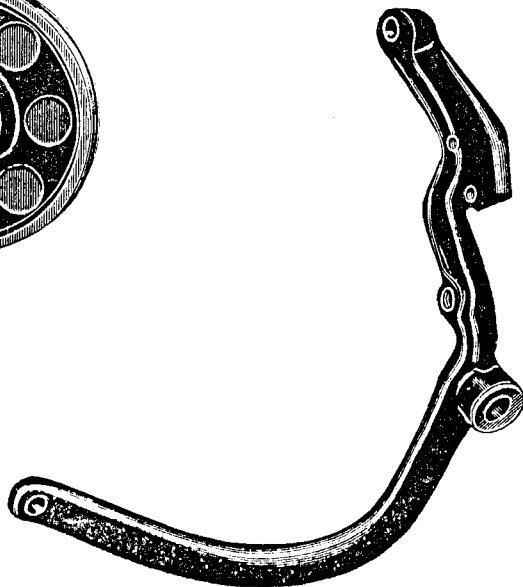

27540

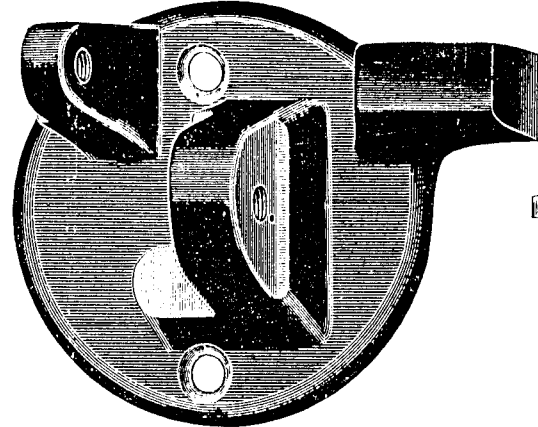

98673



50356



27302

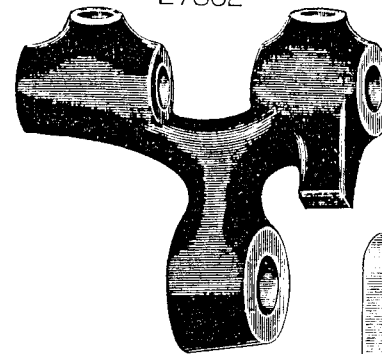

95197

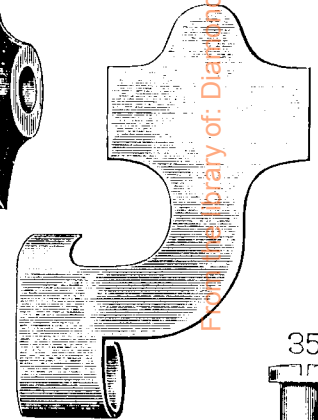

27541

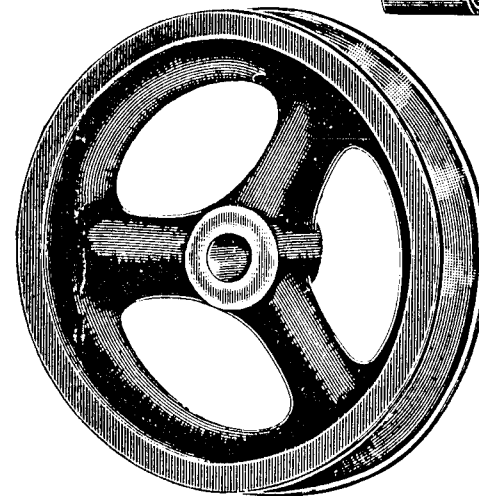

35



1620



27303

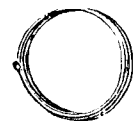

From the Library of: DialingBooks.com

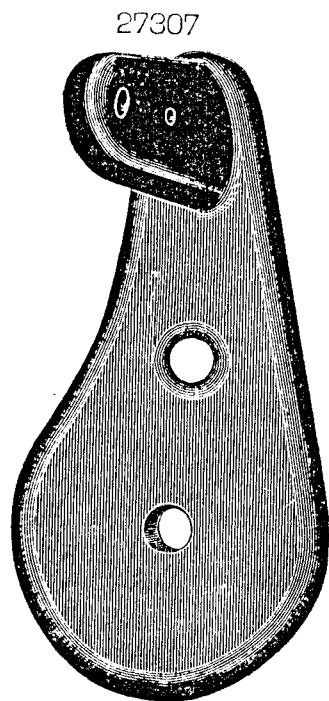
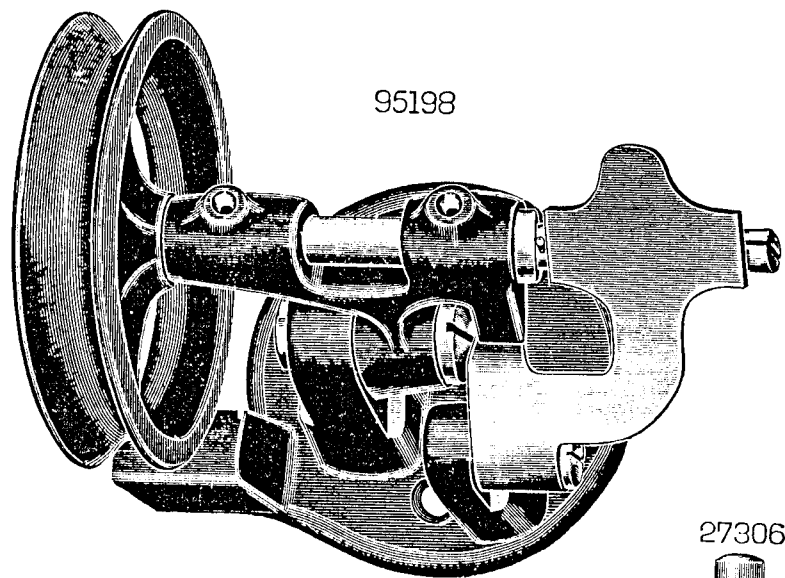

27306

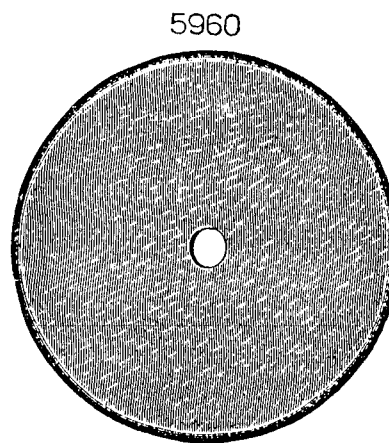
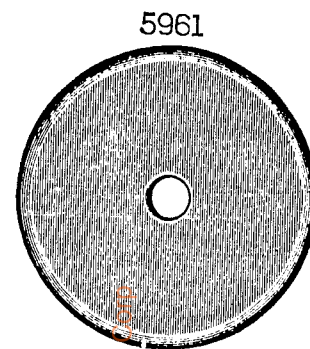
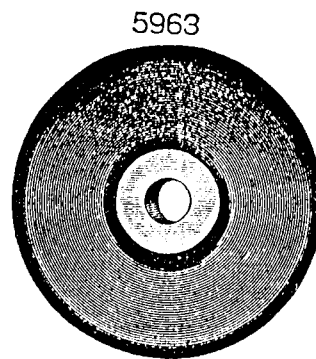

82403

333



94972

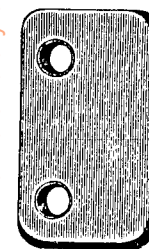

120378

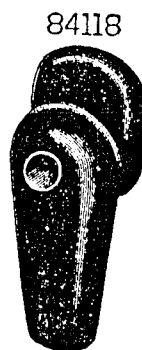

From the library of: Diamond Needle

86611



120342

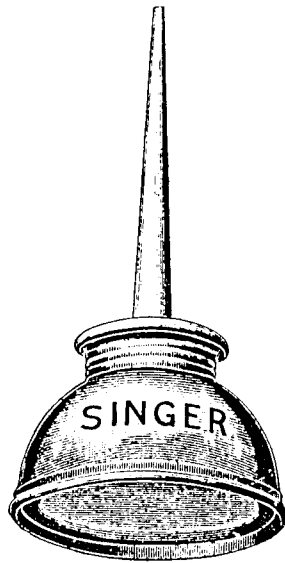

SS22

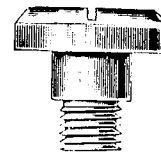

SS32



SS38

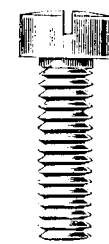

SS39



41



SS45



SS46



32



SS50



SS56



SS65



SS115

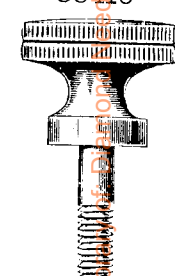

118

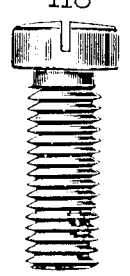

From the collection of the Singer Corp

144

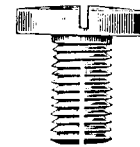

156



157



158

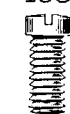

176



180



SS186

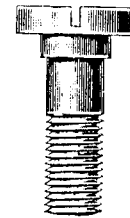

190



207



219



50406



233



313



SS313

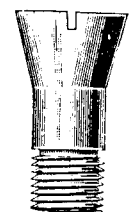

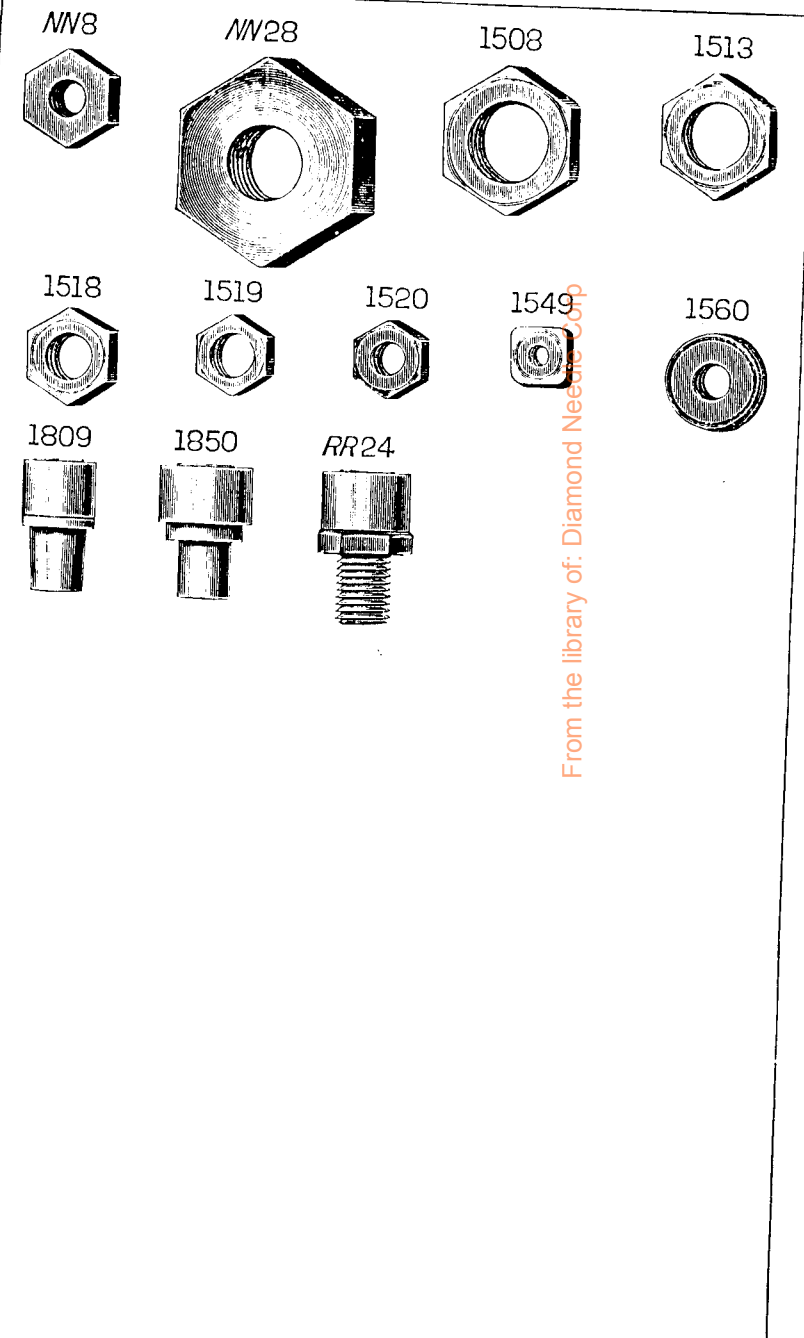
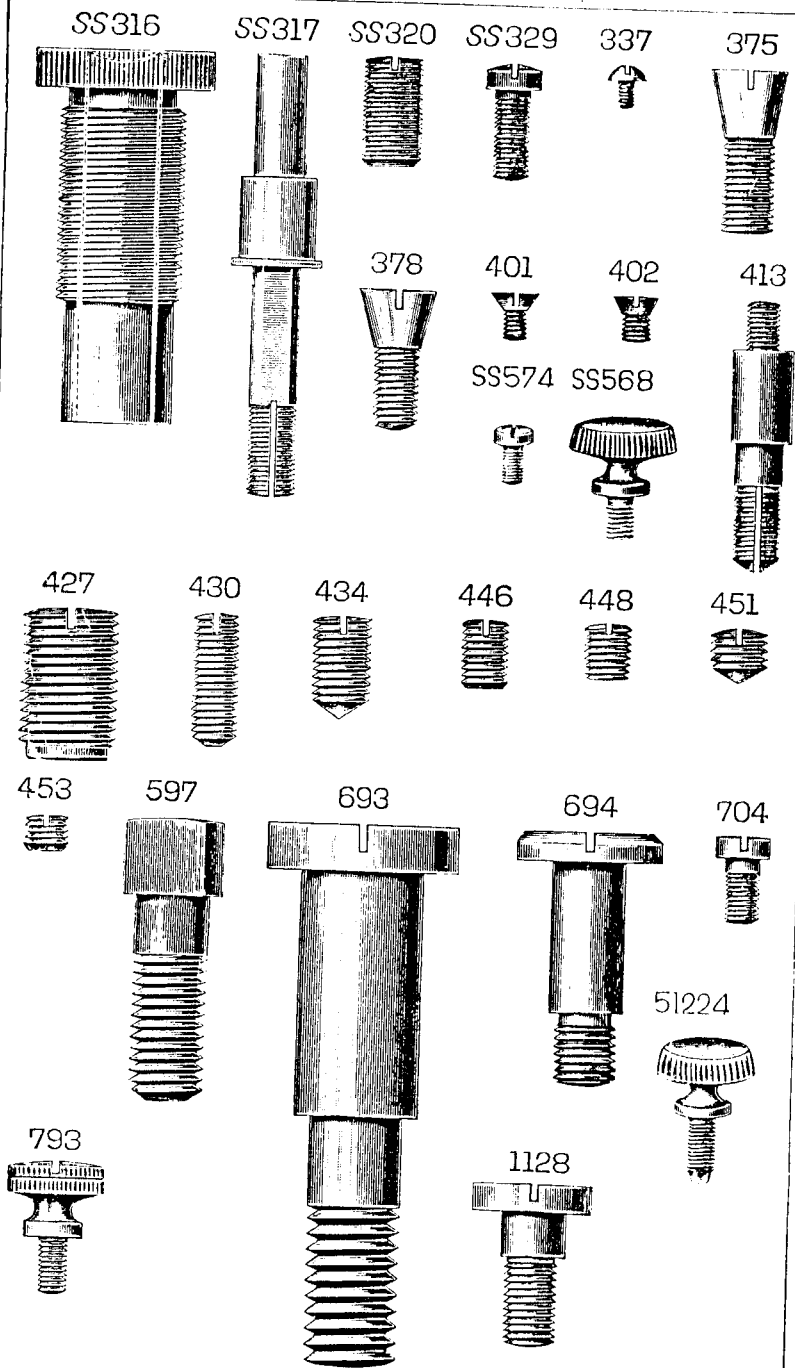

From the library of: Diamond Needle Corp

98624

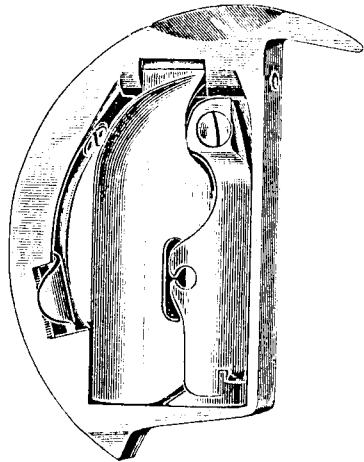

98621

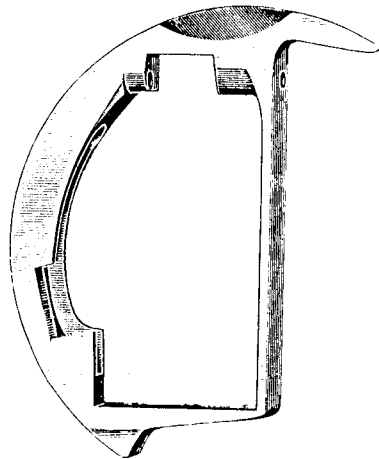

95094

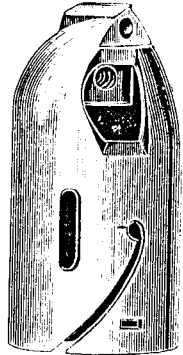

95093

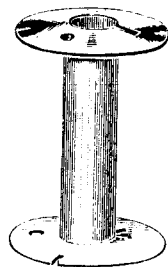

98602



91042



91043

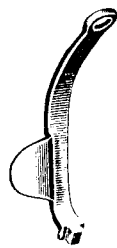

SS377



233



98628

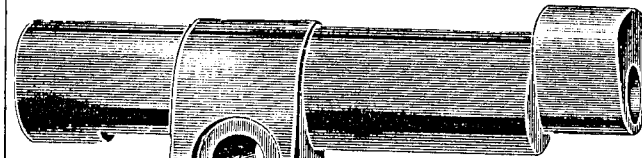

98627

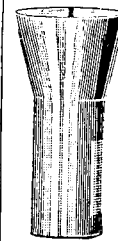

98607

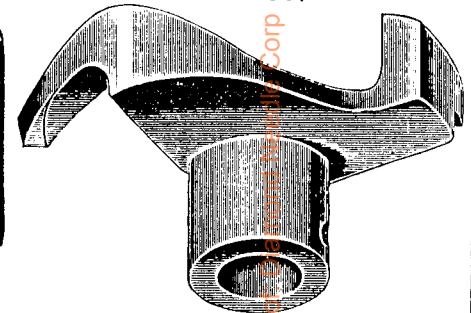

94872



98630

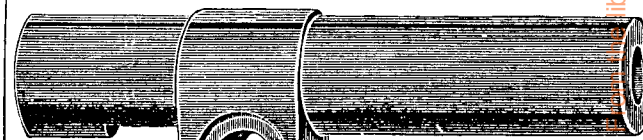

98614



98611

98609

98610

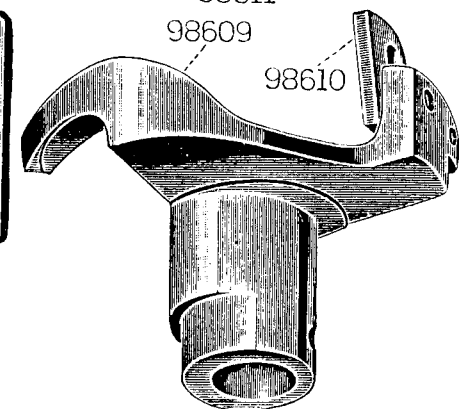

1668



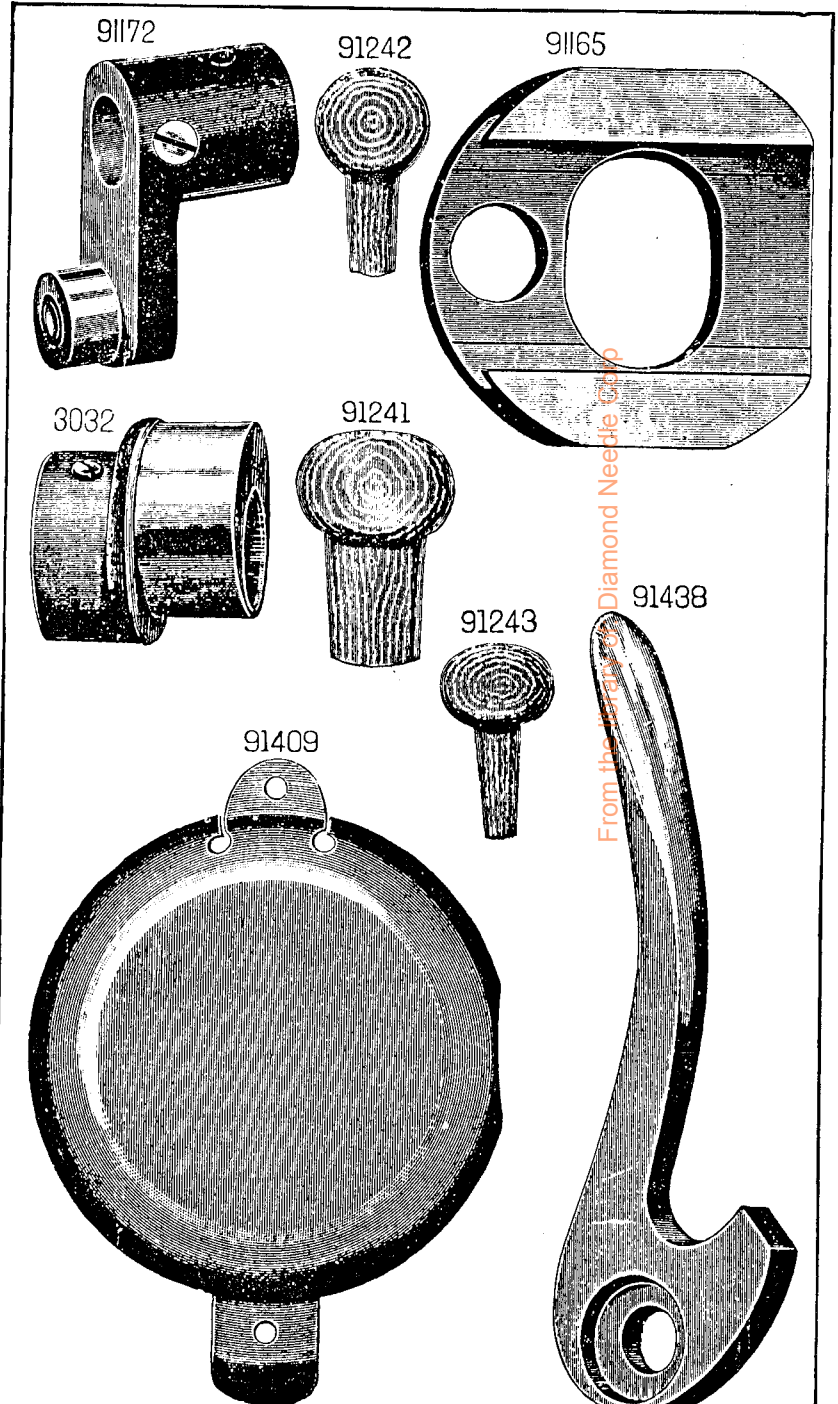
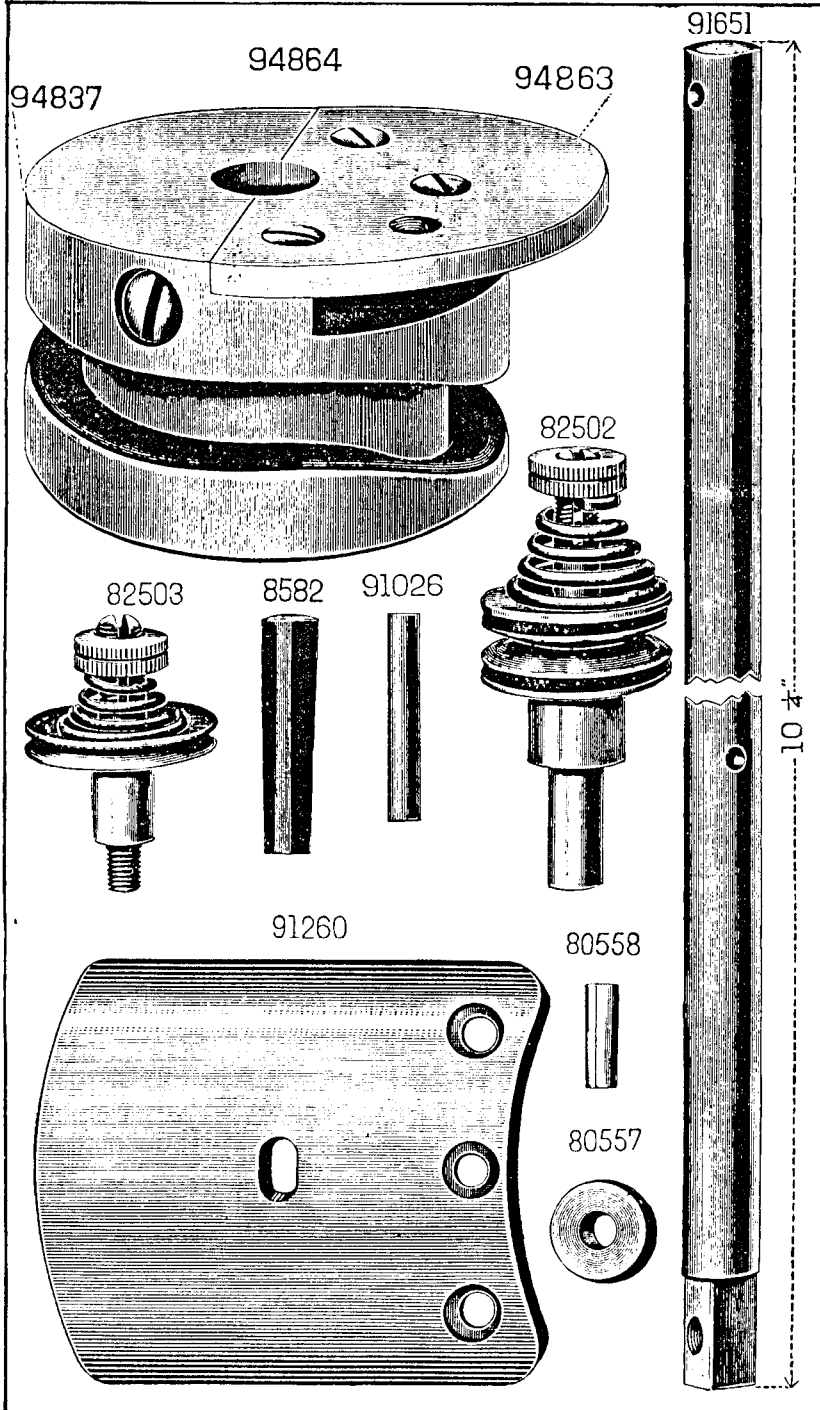

91249

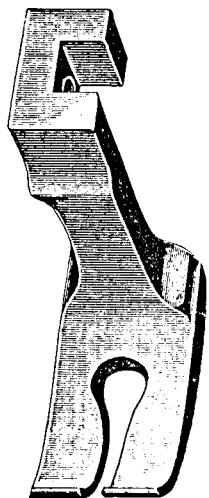

91240

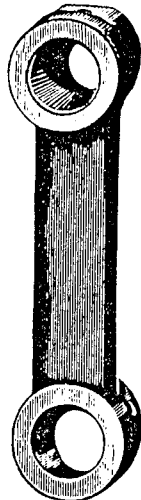

91719

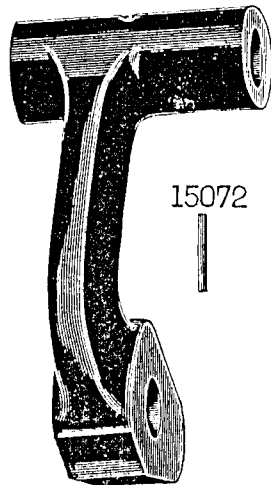

91446



15072



91257

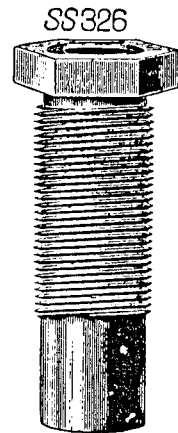
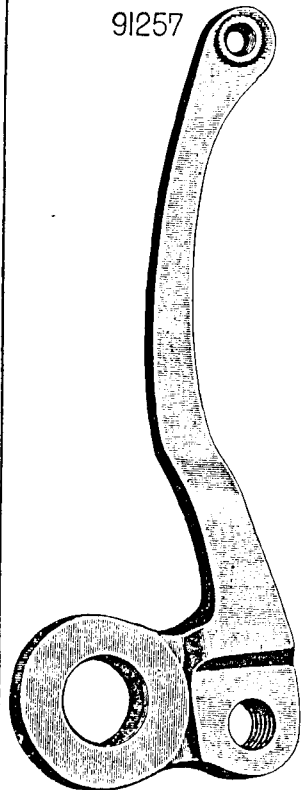

91442

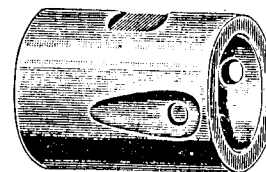

98636

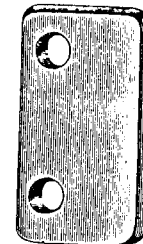

98637

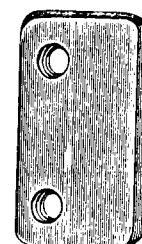

RR62



98633

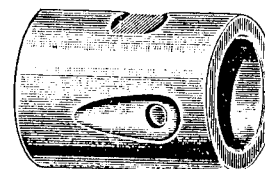

1698



SS208



SS537



SS531



98639

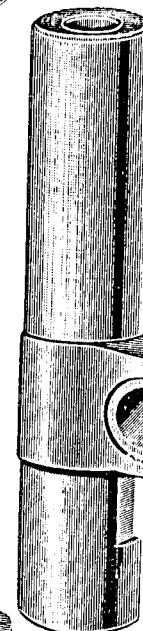

98638

98634

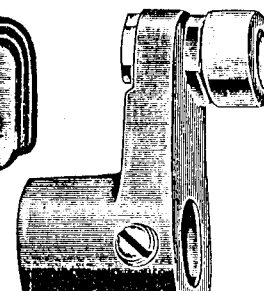

from the library of: Diamond Needle Corp

98680

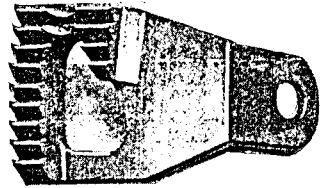

98507

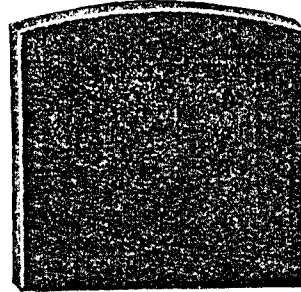

98635

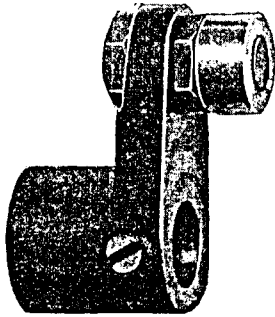

98606



PARTS COMPLETE
FOR
No. 45K76 MACHINE

Cylinder Bed. No Feeding Mechanism. For Sack Darning.

No.	Plate	Description
(561) + 94810	---	Arm with 446c, 450c, 15404, 82499, 82549, 91441 and two 15405
8582	1749	" Dowel Pin (2)
118c	1601	" Screw (3)
91615	1040	Arm Shaft
82499	777	" " Bushing (back)
82549	1054	" " " (front)
446c	1602	" " " Set Screw for 82499
82400	1056	" " Oil Tube
144c	1601	" " Screw
(561) + 82402	775	Arm Side Cover
51224d	1602	" " " Thumb Screw
82403	1489	" Spool Pin
95189	1465	Balance Wheel
(561) + 94811	---	Bed (Cylinder) with 423c and 98633
98606	2354	" Oil Pad
SS463d	1465	Clamp Stop Motion Clamp Screw
248f	1060	" " " " Stop Screw
95145	1465	" " " " Washer
95146	1465	" " " " Flanged Bushing with two 434c
434c	1602	" " " " " Set Screw
95190	---	Clamp Stop Motion, complete, Nos. 248f, SS463d, 95145, 95146 and 95189
94801	775	Crank Connecting Rod with 94802, 94872 and two 458c/09779 (105)
*94802	---	" " " " Cap
94872	1743	" " " " Oil Pad
109779 (105) + 458c	4601 10/62	" " " " Screw
98627	1743	" " " " Hinge Stud
98614	1743	" " " " " Cotter Pin
1668c	1743	" " " " " " Nut
(561) + 94812	1040	Face Plate
SS45d	1601	" " Screw (to attach to machine)
94813	---	Face Plate, complete, Nos. 219f, 233d, 446c, 82449, 82450, 82455, 82502, 82503, 82505, 82551, 94812, 94825, 94836 and

† For Two-Tone Machines the finish of these parts is Grey Metallic (Colour Code No. 728) (561)

No.	Plate	Description
94814	1041	Lifting Presser Plunger
94817	1041	" " " Buffer (rubber)
94815	1041	" " " Pin
94816	1041	" " " Plug
94818	1041	" " " Roller
94819	1041	" " " " Pin
94820	---	Lifting Presser Plunger, complete, Nos. 94814 to 94818, 94819 and five 94817
94821	1041	Lifting Presser Plunger Bracket with two 1186f
1186f	1751	" " " " Clamping Screw
94822	1041	" " " " Spring
193d	1751	" " " " " Screw
91021	775	Needle Bar
91441	779	" " Bushing
450c	1060	" " " Set Screw
91022	779	" " Connection with two 458c/09779 (105) 10/62
19779 (105) + 458c	4601 10/62	" " " Clamping Screw
91240	1751	" " " Link
375c	1602	" " " " Hinge Screw
1518c	1603	" " " " " " Nut
82520	1081	Needle Clamp
82522	---	" " " 82520 with 156f, 50406d and 82521
156f	1601	" " " Screw
82521	1081	" " " Thread Eyelet
50406d	1601	" " " " " Screw
91241	1750	Oil Hole Plug (wood, large)
91242	1750	" " " (" medium)
91243	1750	" " " (" small) (5)
94823	1041	" " " (" small), for Plunger
98639	1769	Oscillating Rock Shaft with 98636, 98637, two each SS537e and 1698c
98642	779	" " " " Hinge Pin
1513j	1603	" " " " " Nut
SS531c	1769	" " " " " Screw Bearing
1513j	1603	" " " " " " Nut
98636	1769	" " " " Steel Plate (bottom)
98637	1769	" " " " " (top)
SS537e	1769	" " " " " Binding Screw
1698c	1769	" " " " " " Lock Nut
98641	---	Oscillating Rock Shaft, complete, Nos. 1668c, 98614, 98627 and 98639

No.	Plate							
91202	1040	Oscillating Shuttle Shaft
98633	1769	"	"	"	Bushing
423c	1060	"	"	"	"	Set Screw
98635	2354	"	"	"	Crank with RR62, 453c and 1518e...
11663	1081	"	"	"	"	Pin
RR62	1769	"	"	"	"	Roller and Screw Stud
1518e	1603	"	"	"	"	"	"	Nut
453c	1602	"	"	"	"	Set Screw
91824	1040	Presser Bar (with squared end)
94826	1041	"	"	"	Cushion Spring
91438	1750	"	"	"	Lifter
SS186d	1601	"	"	"	"	Hinge Screw
1518e	1603	"	"	"	"	"	"	Nut
94827	1041	"	"	"	"	Lifting Bracket with two 1186d
1186d	1751	"	"	"	"	Clamping Screw
94828	1041	"	"	"	"	Sleeve
94829	1041	"	"	"	"	Tension Release
157f	1601	"	"	"	"	"	"	Binding Screw (2)
SS125e	1044	"	"	"	"	Screw Bushing
91248	779	"	"	"	"	Spring
94830	1041	Presser Foot
SS329f	1602	"	"	"	"	Screw
1547c	1751	"	"	"	"	Nut
95093	1696	Shuttle Bobbin
95094	1696	"	"	"	"	Cylinder
91042	1696	"	"	"	"	Hinge Pin
91043	1696	"	"	"	"	Latch Spring
SS574d	1602	"	"	"	"	"	"	Screw
98621	1696	"	"	"	"	Frame
98602	1696	"	"	"	"	Tension Spring
SS377f	1696	"	"	"	"	"	"	Adjusting Screw
98624	1696	Shuttle (Cylinder, 2½" diam., complete, Nos. SS377f, SS574d, 91042, 91043, 95093, 95094 98602 and 98621
<i>No. 98624 can only be used with No. 98611 and not with old style Shuttle Drivers.</i>								
98609	1743	Shuttle Driver and Feed Raising Cam
11663	1081	"	"	"	"	Pin
98610	1743	"	"	"	"	Thread Guard
223d	1060	"	"	"	"	"	"	Screw
98611	1743	Shuttle Driver and Feed Raising Cam , complete, Nos. 98609, 98610 and two 223d
<i>No. 98611 can only be used with No. 98624 and not with old style Shuttles.</i>								

No.	Plate							
91753	1043	Shuttle Race (steel, hardened)
91315	777	"	"	"	"	Cap Spring
SS218d	1751	"	"	"	"	"	"	Screw
SS318e	1751	"	"	"	"	Position Screw Stud (2)
91153	1044	"	"	"	"	Ring
1302c	1060	"	"	"	"	"	"	Screw (3)
SS317e	1602	Tension Screw Stud
1560d	1603	"	"	"	"	Regulating Thumb Nut
446c	1602	"	"	"	"	Set Screw
82445	1081	"	"	"	"	Spring
82446	779	"	"	"	"	Washer (felt)
82447	1081	"	"	"	"	(steel)
82448	779	"	"	"	"	Wheel
82502	1749	Tension , complete, Nos. SS317e, 1560d, 82445, 82448, two each 82446 and 82447
94836	1041	Tension Thread Guide
SS50f	1601	"	"	"	"	"	"	Screw
82551	1041	Thread Controlling Lever
82525	1081	"	"	"	"	Spring
82455	779	"	"	"	"	Stop Pin
82450	1081	Thread Eyelet
SS50f	1601	"	"	"	"	"	"	Screw
82449	1081	"	"	"	"	Guard
233d	1696	"	"	"	"	"	"	Screw
2102	779	Thread Retainer Disc
*413e	1602	"	"	"	"	"	"	Screw Stud
33892	—	"	"	"	"	"	"	413e with 1560d
1560d	1603	"	"	"	"	"	"	Regulating Thumb Nut
2103	1081	"	"	"	"	Spring
82503	1749	Thread Retainer , complete, Nos. 2103, 33892 and two 2102
94837	1043	Thread Take-up Cam with SS320c and SS370c
94839	1043	"	"	"	"	94837 with 94838 and three 191c
94838	1043	"	"	"	"	Lifting Cam
191c	1060	"	"	"	"	"	"	Screw
SS320c	1602	"	"	"	"	Set Screw
SS370c	1060	"	"	"	"	Timing Screw

From the library of: Diamond Needle Corp

No.	Plate						
91257	1751	Thread Take-up Lever with 9219
91258	---	" " " 91257 with RR24 and 1519c
SS22f	1601	" " " Hinge Screw
RR24	1603	" " " Roller and Screw Stud
1519c	1603	" " " " " " " Nut
*9219	---	" " " Thread Eyelet Bushing
94825	1041	" " " Spring Regulator
219f	1601	" " " " " Screw
94840	1044	Throat Plate
180f	1601	" " Screw (3)
94841	---	Work Plate
SS39d	1601	" " Screw
*15404	---	Trade Mark
15405	---	" " Rivet

STOP!

PARTS SPECIAL

TO

No. 45K75 MACHINE

Cylinder Bed. No Feeding Mechanism. Fast and Loose Pulleys and Belt Shipper. For Sack Darning.

This machine is the same as 45K76 with the following exceptions:--

No.	Plate						
*95154	---	Arm with 446c, 450c, 15404, 82499, 82549, 91441 and two 15405
95141	1466	Balance Wheel
95142	1466	" " Loose Pulley
95143	---	Balance Wheel, complete, Nos. 95141 and 95142 for fast and loose pulley
98625	---	Clamp Stop Motion, complete, Nos. 248f, SS463d, 95143, 95145 and 95146
98643	1466	Driving Attachment Lever
727c	1060	" " " Adjusting Screw
1623c	1060	" " " " " Nut
95148	1057	" " " Belt Shifter
363c	1060	" " " " " Clamping Screw
95149	1057	" " " " " Rod
363c	1060	" " " " " Clamping Screw
91302	1082	" " " Bracket
SS38c	1601	" " " " " Screw
98507	2354	" " " Friction Pad (leather)
190d	1601	" " " " " Screw
693d	1602	" " " Hinge Screw
NN28e	1603	" " " " " Nut
95150	1057	" " " Spring
7958	1057	" " " " " Pin
95152	---	Driving Attachment Lever, complete, Nos. NN28e, 693d, 727c, 1623c, 7958, 91302, 95149, 95150, 98507, 98643, two each SS38c, 190d, 95148 and three 363c
84275	---	Driving Attachment Shaft Pulley (sectional, grooved) 10" diam., with two 597c
597c	1602	" " " " " Clamping Screw

From the library of: Diamond Needle Corp

Accessories

No.	Plate	
—	—	Instruction Book
51077e	1060	Machine Bolt, with 1524e, 3" x 1/4" (4), for 45K57, 45K75 and 45K76 Machines
6055	1056	Machine Bolt Washer (4) for 45K57, 45K75 and 45K76 Machines
84118	1489	Machine Button, with 84151 and wood screw 1 1/4" No. 9 R.H.B., for 45K87 Machine
(5-61) 4951	—	Needles (6) (2-14 x 5) 5-61
120342	1600	Oiler 2-27/6-59
86611	1600	Screw Driver (large)
120378	1489	" " (Shuttle Tension) 7-60 120378 will be supplied with stock is exhausted
95093	1696	Shuttle Bobbin (2) 9/5
80107	1056	Wrench for 1547

Thread Unwinder

No.	Plate	
27623	1401	Spool Pin
84148	1401	" Rest with 448c
95126	1401	" Weight 4" dia. (only supplied when specified on order)
27625	1401	Thread Eyelet Rod
448c	1602	" " " Set Screw
27626	1401	" " Wire
27627	—	Thread Eyelet, complete, Nos. 27625 and 27626
—	—	Screw (wood) 1 1/4" No. 10 (for fixing to table)
95125	1401	Thread Unwinder, complete, Nos. 27623, 27627, 84148 and two wood screws 1 1/4" No. 10

Bobbin Winders

BOBBIN WINDER (Friction) for Fast Wheel and S.D.A. Machines

No.	Plate	
5-61 † 91718	1040	Bracket
SS56d	1601	" Screw
5-61 † 91719	1751	Frame
32d	1601	" Hinge Screw
5960	1489	Friction Wheel (leather)
5961	1489	" " Washer
333r	1489	" " " Screw
91446	1751	Spindle with 15072
15072	1751	" Bobbin Position Pin
5963	1489	" Flange
91725	1040	Frame, complete, Nos. 333r, 5960, 5961, 5963, 91446 and 91719
82537	1040	Spring
161d	1601	" Screw
82538	1040	" " Washer
91720	—	Bobbin Winder , complete, Nos. 32d, 161d, 82537, 82538, 91718 and 91725

BOBBIN WINDER (Swinging Automatic, Right Hand) for 95093

No.	Plate	
27540	1487	Base
—	—	" Screw (wood) 1" No. 7 R.H.
27302	1487	Frame
50356b	1487	" Hinge Screw
1620j	1487	" " " Nut
27303	1487	" Spring
27541	1487	Pulley
98673	1487	Spindle with 15072
15072	1751	" Bobbin Position Pin
27306	1488	Spool Pin
27307	1488	" Stand
† 27308	—	" " 27307, with 418d, 1562j, 2106, 10141, 27306, two each 2455 and wood screws 1" No. 10
95197	1487	Stop Latch
35d	1060	" " Hinge Screw
2455	1488	Tension Disc
1562j	1488	" Regulating Thumb Nut
418d	1488	" Screw Stud
10141	1488	" Spring
2106	1488	Thread Guide
95198	1488	Bobbin Winder, Nos. 35d, 1620j, 27302, 27303, 27540, 27541, 50356b, 95197, 98673 and two wood screws 1" No. 7 R.H.
95199	—	Bobbin Winder (Swinging Automatic, right hand), complete, Nos. 27308 and 95198

† As No. 27308 can be supplied either Plated or Japanned, it is necessary when ordering to state which is required.

† For Two-Tone Machines the finish of these parts is Grey Metallic (Colour Code No. 728). (5-61)

Foot Lifter for Nos. 45K57 and 45K87 Machines

No.	Plate	
91716	1061	Arm Lever
694d	1602	" " Hinge Screw
91457	1061	Foot Lever with 176c
91459	1061	" " Bracket
17881	1061	" " " Hinge Pin
—	—	" " " Screw (wood) 1" No. 12
91458	1061	" " Extension
176c	1601	" " " Set Screw
98626	1061	" " Spring
91454	—	Foot Lever only, complete, Nos. 17881, 91457 to 91459, 98626 and two wood screws 1" No. 12... ..
91453	1061	Foot Lever Pitman Connecting Hook (7" long)
17877	1061	" " " Rod (lower)
17878	1061	" " " " (upper)
17879	1061	" " " " Clamp with two 161d
161d	1601	" " " " Screw
17880	1061	Foot Lever Pitman Rod, complete, Nos. 17877 to 17879
91455	—	Foot Lever, complete, Nos. 17880 and 91454
91456	—	Foot Lifter , complete, Nos. 694d, 91453, 91455 and 91716

Foot Lifter for 45K75 and 45K76 Machines

This Foot Lifter is the same as 91456 with the following exceptions:—

No.	Plate	
94842	1061	Arm Lever
94843	—	Foot Lifter , complete, Nos. 694d, 91453, 91455 and 94842

Driving Attachment

No.	Plate	
91614	1082 ✓	Balance Wheel with 434c, 451c, 91475 and four 402c
91723	1082 ✓	" " Friction Pulley (two-speeds) with 448c and 91294
91294	1082 ✓	" " " " Centre Bearing
91475	1082 ✓	" " " " Ring (cardboard)
402e	1602 ✓	" " " " " Screw
448c	1602 ✓	" " " " " Set Screw
434c	1602 ✓	" " " " Set Screw (long)
451c	1602 ✓	" " " " (short)
91721	1082 ✓	Lever with 7958 and 91306
91302	1082 ✓	" Bracket
SS38c	1601 ✓	" " Screw
91303	1082 ✓	" Centre Plug (wood)
427c	1602 ✓	" " " Adjusting Screw
1508e	1603 ✓	" " " " " Nut
91306	1057 ✓	" Friction Pad (leather)
693d	1602 ✓	" Hinge Screw
NN28e	1603 ✓	" " " Nut
91307	779 ✓	" Spring
161c	1601 ✓	" " " Screw
7958	1057 ✓	" " " Pin
91722	— ✓	Lever, complete, Nos. NN28e, 161c, 427c, 693d, 1508e, 91302, 91303, 91307, 91721 and two SS38c
84275	1082 ✓	Shaft Pulley (sectional, grooved) 10" diam., with two 597c
597c	1602 ✓	" " Clamping Screw
91296	1061 ✓	Starting Lever
91297	1061 ✓	" " Bracket
91298	1057 ✓	" " " Hinge Pin
—	— ✓	" " " Screw (wood) 1 1/4" No. 15
91299	1061 ✓	" " Nos. 91296 to 91298 and three wood screws 1 1/4" No. 15
17877	1061 ✓	" " Pitman Rod (lower)
17878	1061 ✓	" " " " (upper)
17879	1061 ✓	" " " " Clamp with two 161d
161d	1601 ✓	" " " " " Screw
17880	1061 ✓	Starting Lever Pitman Rod, complete, Nos. 17877 to 17879
91460	— ✓	Starting Lever and Pitman, complete, Nos. 17880 and 91299
91724	—	Driving Attachment , complete, Nos. 84275, 91460, 91614, 91722 and 91723

Obsolete Parts

No.	Plate	
91025	779	Oscillating Rock Shaft Steel Plate (bottom) for 98628 and 98630
94972	1489	" " " " " (top) for 98628 and 98630 ...
91026	1749	" " " " " Rivet for 98628 and 98630 ...
98628	1743	" " " " with 91025, 94972 and two 91026, for 45K87 Machine
98630	1743	" " " " 91025, 94972 and two 91026, for 45K57, 45K75 and 45K76 Machines

Numerical List of Parts

No.	Plate	
NN8e	1603	Shuttle Race Bearing Clamping Screw Nut for 45K87 Machine
SS22f	1601	Thread Take-up Lever Hinge Screw ...
RR24	1603	Thread Take-up Lever Roller and Screw Stud for 91258 and 94866
NN28e	1603	Driving Attachment Lever Hinge Screw Nut for 91722 and 95152
32d	1601	Bobbin Winder Frame Hinge Screw for 91720
SS32f	1601	Shuttle Race Bearing Clamping Screw for 45K87 Machine
35d	1060	Bobbin Winder Stop Latch Hinge Screw for 95198
SS38c	1601	Driving Attachment Lever Bracket Screw for 91722 and 95152
SS39c	1601	Oscillating Shuttle Shaft Bushing Set Screw for 45K87 Machine
SS39d	1601	Work Plate Screw for 45K57, 45K75 and 45K76 Machines
41d	1601	Shuttle Race Cap Spring Screw for 94862 ...
SS45d	1601	Face Plate Screw (to attach to machine) ...
SS50f	1601	Thread Eyelet Screw for 91234, 94813 and 94856
SS50f	1601	Tension Thread Guide Screw for 94813 ...
SS56d	1601	Bobbin Winder Bracket Screw for 91720 ...
RR62	1769	Oscillating Shuttle Shaft Crank Roller and Screw Stud for 98635
SS115d	1601	Feed Regulator Thumb Screw for 45K57 Machine
118e	1601	Arm Screw
144c	1601	Arm Shaft Screw
149f	1060	Lifting Presser Plunger Yoke Clamping Screw for 91239
149f	1060	Lifting Presser Plunger Yoke Set Screw for 91239
156f	1601	Feed Rock Shaft Crank Position Screw for 98674
156f	1601	Needle Clamp Screw for 82522
157f	1601	Presser Bar Lifting Bracket Tension Release Binding Screw for 45K75 and 45K76 Machines
158e	1601	Crank Connecting Rod Cap Screw for 94801 and 98664
158e	1601	Needle Bar Connection Clamping Screw for 91022

No. Canceled
under
104779 (805)
10/12

From the library of: Diamond Speed Corp

NUMERICAL LIST OF PARTS

No.	Plate	
161c	1601	Driving Attachment Lever Spring Screw for 91722
161d	1601	Bobbin Winder Spring Screw for 91720
161d	1601	Driving Attachment Starting Lever Pitman Rod Clamp Screw for 17879
161d	1601	Foot Lifter Foot Lever Pitman Rod Clamp Screw for 17879
176c	1601	Foot Lifter Foot Lever Extension Set Screw for 91457
180f	1601	Arm Cover Screw for 45K87 Machine
180f	1601	Shuttle Race Slide (back) Screw for 45K87 Machine
180f	1601	Throat Plate Screw
SS186d	1601	Presser Bar Lifter Hinge Screw
190d	1601	Driving Attachment Lever Friction Pad Screw for 95152
190f	1601	Presser Bar Lifting Bracket Tension Release Binding Screw for 91711
191c	1060	Thread Take-up Cam Lifting Cam Screw for 94839 and 94864
193d	1751	Lifting Presser Plunger Bracket Spring Screw for 45K75, 45K76 and 45K87 Machines
SS208f	1769	Throat Plate Oil Hole Screw for 45K57 Machine
SS218d	1751	Shuttle Race Cap Spring Screw for 45K57, 45K75 and 45K76 Machines
219f	1601	Thread Take-up Spring Regulator Screw for 91234, 94813 and 94856
223d	1060	Shuttle Driver Thread Guard Screw for 98611
233d	1696	Thread Guard Screw for 91234, 94813 and 94856
248f	1060	Clamp Stop Motion Clamp Stop Screw for 95190 and 98625
SS317e	1602	Tension Screw Stud for 82502
SS318e	1751	Shuttle Race Position Screw Stud for 45K57, 45K75 and 45K76 Machines
SS320c	1602	Thread Take-up Cam Set Screw for 94837
SS326e	1751	Presser Bar Screw Bushing for 45K57 Machine
SS329f	1602	Presser Foot Screw
333r	1489	Bobbin Winder Friction Wheel Washer Screw for 91725
337d	1602	Shuttle Race Slide (front) Spring Screw for 91060
363c	1060	Driving Attachment Lever Belt Shifter Clamping Screw for 95152

NUMERICAL LIST OF PARTS

No.	Plate	
363c	1060	Driving Attachment Lever Belt Shifter Rod Clamping Screw for 95152
SS370c	1060	Thread Take-up Cam Timing Screw for 94837
375c	1602	Feed Connecting Link Hinge Screw for 45K57 Machine
375c	1602	Feed Forked Connection Hinge Screw for 45K57 Machine
375c	1602	Needle Bar Connection Link Hinge Screw
SS377f	1696	Shuttle Tension Spring Adjusting Screw for 98624
397e	1060	Lifting Presser Dash Pot Screw for 45K87 Machine
401f	1602	Shuttle Race Loop Spreader Screw for 94973
402c	1602	Driving Attachment Balance Wheel Friction Pulley Ring Screw for 91614
*413c	1602	Thread Retainer Screw Stud for 33892
418d	1488	Bobbin Winder Tension Screw Stud for 27308
423c	1060	Oscillating Shuttle Shaft Bushing Set Screw for 91151 and 94811
SS425e	1044	Presser Bar Screw Bushing for 45K75, 45K76 and 45K87 Machines
427c	1602	Driving Attachment Lever Centre Plug Adjusting Screw for 91722
434c	1602	Balance Wheel Set Screw for 91613
434c	1602	Clamp Stop Motion Flanged Bushing Set Screw for 95146
434c	1602	Driving Attachment Balance Wheel Set Screw for 91614
446c	1602	Arm Shaft Bushing Set Screw for 91444, 94810, 94853 and 95154
446c	1602	Feed Cam Set Screw for 3032
446c	1602	Presser Bar Lifting Bracket Set Screw for 91652
446c	1602	Tension Screw Stud Set Screw for 91234, 94813 and 94856
448c	1602	Driving Attachment Balance Wheel Friction Pulley Set Screw for 91723
448c	1602	Thread Unwinder Thread Eyelet Rod Set Screw for 84148
450a	1060	Needle Bar Bushing Set Screw for 91444, 94810, 94853 and 95154
451c	1602	Driving Attachment Balance Wheel Set Screw for 91614
453c	1602	Oscillating Shuttle Shaft Crank Set Screw for 91172 and 98635

From the library of: Diamond Needle Corp.

NUMERICAL LIST OF PARTS

No.	Plate	
453c	1602	Oscillating Shuttle Shaft Collar Set Screw for 91030
SS463d	1465	Clamp Stop Motion Clamp Screw for 95190 and 98625
SS517c	1054	Feed Rock Shaft Crank Clamping Screw for 98674
SS531c	1769	Oscillating Rock Shaft Hinge Pin Screw Bearing
SS537e	1769	Oscillating Rock Shaft Steel Plate Binding Screw for 98638 and 98639
SS574d	1602	Shuttle Cylinder Latch Spring Screw for 98624
597c	1602	Driving Attachment Shaft Pulley Clamping Screw for 84275
693d	1602	Driving Attachment Lever Hinge Screw for 91722 and 95152
694d	1602	Foot Lifter Arm Lever Hinge Screw for 91456 and 94843
704c	1602	Feed Dog Screw for 45K57 Machine
727c	1060	Driving Attachment Lever Adjusting Screw for 95152
1128e	1602	Feed Regulator Hinge Screw for 45K57 Machine
1186d	1751	Presser Bar Lifting Bracket Clamping Screw for 94827 and 94861
1186f	1751	Lifting Presser Plunger Bracket Clamping Screw for 94821 and 94857
1259c	1060	Feed Rock Shaft Carrier Slide Set Screw for 91165 252
1302e	1060	Shuttle Race Ring Screw for 45K57, 45K75 and 45K76 Machines
1508e	1603	Driving Attachment Lever Centre Plug Adjusting Screw Nut for 91722
1513j	1603	Oscillating Rock Shaft Hinge Pin Nut
1513j	1603	Oscillating Rock Shaft Hinge Pin Screw Bearing Nut
1518e	1603	Feed Connecting Link Hinge Screw Nut for 45K57 Machine
1518e	1603	Feed Forked Connection Hinge Screw Nut for 45K57 Machine
1518e	1603	Needle Bar Connection Link Hinge Screw Nut
1518e	1603	Oscillating Shuttle Shaft Crank Roller and Screw Stud Nut for 98635
1518e	1603	Presser Bar Lifter Hinge Screw Nut
1519e	1603	Thread Take-up Lever Roller and Screw Stud Nut for 91258 and 94866

NUMERICAL LIST OF PARTS

No.	Plate	
1547c	1751	Presser Foot Screw Nut
1560d	1603	Tension Screw Stud Regulating Thumb Nut for 82502
1560d	1603	Thread Retainer Screw Stud Regulating Thumb Nut for 33892
1562j	1488	Bobbin Winder Tension Regulating Thumb Nut for 27308
1620j	1487	Bobbin Winder Frame Hinge Screw Nut for 95198
1623c	1060	Driving Attachment Lever Adjusting Screw Nut for 95152
1668c	1743	Crank Connecting Rod Hinge Stud Cotter Pin Nut for 98640 and 98641
1698c	1769	Oscillating Rock Shaft Steel Plate Binding Screw Lock Nut for 98638 and 98639
1850	1603	Oscillating Shuttle Shaft Crank Roller and Stud for 91172
2102	779	Thread Retainer Disc for 82503
2103	1081	Thread Retainer Spring for 82503
2106	1488	Bobbin Winder Thread Guide for 27308
2117	1055	Lifting Presser Plunger Yoke Pin for 45K57 Machine
2455	1488	Bobbin Winder Tension Disc for 27308
3032	1750	Feed Cam, with 446c, for 45K57 Machine
5960	1489	Bobbin Winder Friction Wheel (leather) for 91725
5961	1489	Bobbin Winder Friction Wheel Washer for 91725
5963	1489	Bobbin Winder Spindle Flange for 91725
6055	1056	Machine Bolt Washer for 45K57, 45K75 and 45K76 Machines (Accessories)
7958	1057	Driving Attachment Lever Spring Pin for 95152
7958	1057	Driving Attachment Lever Spring Screw Pin for 91721
8575	1055	Presser Bar Lifting Bracket Pin for 45K57 Machine
8582	1749	Arm Dowel Pin
*9219	—	Thread Take-up Lever Thread Eyelet Bushing for 91257 and 94865
10141	1488	Bobbin Winder Tension Spring for 27308
11663	1081	Oscillating Shuttle Shaft Crank Pin
11663	1081	Shuttle Driver Pin
15072	1751	Bobbin Winder Spindle Bobbin Position Pin for 91446 and 98673
*15404	—	Trade Mark for 91444, 94810, 94853 and 95154

NUMERICAL LIST OF PARTS

No.	Plate	
15405	—	Trade Mark Rivet for 91444, 94810, 94853 and 95154
17877	1061	Driving Attachment Starting Lever Pitman Rod (lower) for 17880
17877	1061	Foot Lifter Foot Lever Pitman Rod (lower) for 17880
17878	1061	Driving Attachment Starting Lever Pitman Rod (upper) for 17880
17878	1061	Foot Lifter Foot Lever Pitman Rod (upper) for 17880
17879	1061	Driving Attachment Starting Lever Pitman Rod Clamp, with two 161d, for 17880
17879	1061	Foot Lifter Foot Lever Pitman Rod Clamp with two 161d, for 17880
17880	1061	Driving Attachment Starting Lever Pitman Rod, complete, Nos. 17877 to 17879 for 91460
17880	1061	Foot Lifter Foot Lever Pitman Rod, complete, Nos. 17877 to 17879 for 91455
17881	1061	Foot Lifter Foot Lever Bracket Hinge Pin for 91454
27302	1487	Bobbin Winder Frame for 95198
27303	1487	Bobbin Winder Frame Spring for 95198
27306	1488	Bobbin Winder Spool Pin for 27308
27307	1488	Bobbin Winder Spool Stand for 27308
†27308	—	Bobbin Winder Spool Stand 27307, with 418d, 1562j, 2106, 10141, 27306, two each 2455 and wood screws 1" No. 10 for 95199
27540	1487	Bobbin Winder Base for 95198
27541	1487	Bobbin Winder Pulley for 95198
27623	1401	Thread Unwinder Spool Pin for 95125
27625	1401	Thread Unwinder Thread Eyelet Rod for 27627
27626	1401	Thread Unwinder Thread Eyelet Wire for 27627
27627	—	Thread Unwinder Thread Eyelet, complete, Nos. 27625 and 27626, for 95125
33892	—	Thread Retainer Screw Stud 413e with 1560d, for 82503
50356b	1487	Bobbin Winder Frame Hinge Screw for 95198
50406d	1601	Needle Clamp Thread Eyelet Screw for 82522
51077e	1060	Machine Bolt, with 1524e, 3" x 1/4", for 45K57, 45K75 and 45K76 Machines (Accessories)
51224d	1602	Arm Side Cover Thumb Screw
52165	1081	Feed Connecting Link for 45K57 Machine

†As No. 27308 can be supplied either Plated or Japanned, it is necessary, when ordering, to state which is required.

NUMERICAL LIST OF PARTS

No.	Plate	
80107	1056	Wrench for 1547 ... (Accessories)
80557	1749	Lifting Presser Plunger Roller for 91691 ...
80558	1749	Lifting Presser Plunger Roller Pin for 91691 ...
82400	1056	Arm Shaft Oil Tube
(56) † 82402	775	Arm Side Cover
82403	1489	Arm Spool Pin
82414	777	Feed Regulator for 45K57 Machine
82445	1081	Tension Spring for 82502
82446	779	Tension Washer (felt) for 82502
82447	1081	Tension Washer (steel) for 82502
82448	779	Tension Wheel for 82502
82449	1081	Thread Guard for 91234, 94813 and 94856
82450	1081	Thread Eyelet for 91234, 94813 and 94856
82455	779	Thread Controlling Lever Stop Pin for 91234, 94813 and 94856
82499	777	Arm Shaft Bushing (back) for 91444, 94810, 94853 and 95154
82502	1749	Tension, complete, Nos. SS317e, 1560d, 82445, 82448, two each 82446 and 82447 for 91234, 94813 and 94856
82503	1749	Thread Retainer, complete, Nos. 2103, 33892 and two 2102 for 91234, 94813 and 94856
82510	1056	Presser Bar Lifting Bracket Tension Release for 91711
82520	1081	Needle Clamp for 82522
82521	1081	Needle Clamp Thread Eyelet for 82522
82522	—	Needle Clamp 82520 with 156f, 50406d and 82521
82525	1081	Thread Controlling Lever Spring for 91234, 94813 and 94856
82537	1040	Bobbin Winder Spring for 91720
82538	1040	Bobbin Winder Spring Screw Washer for 91720
82549	1054	Arm Shaft Bushing (front) for 91444, 94810, 94853 and 95154
82550	—	Drip Pan for 45K87 Machine
82551	1041	Thread Controlling Lever for 91234, 94813 and 94856
84118	1489	Machine Button, with 84151 and wood screw 1 1/4" No. 9 R.H.B., for 45K87 Machine (Accessories)
84148	1401	Thread Unwinder Spool Rest, with 448c, for 95125
84275	1082	Driving Attachment Shaft Pulley (sectional, grooved), 10" diam., with two 597c, for 91724 and 95153
86611	1600	Screw Driver (large) ... (Accessories)

† For Two-Tone Machines the finish of these parts is Grey Metallic (Colour Code No. 728). (56)

No.	Plate	
*91003	—	Bed for 45K87 Machine
91021	775	Needle Bar
91022	779	Needle Bar Connection with two-158c/09 729 (205) 10/62
91025	779	Oscillating Rock Shaft Steel Plate (bottom) for 98628 and 98630 ... (Obsolete)
91026	1749	Oscillating Rock Shaft Steel Plate Rivet for 98628 and 98630 ... (Obsolete)
91028	776	Oscillating Shuttle Shaft for 45K87 Machine
91029	1081	Oscillating Shuttle Shaft Bushing for 45K87 Machine
91030	1055	Oscillating Shuttle Shaft Collar, with 453c, for 45K87 Machine
91042	1696	Shuttle Cylinder Hinge Pin for 98624
91043	1696	Shuttle Cylinder Latch Spring for 98624
91049	1055	Shuttle Race, with 91051, 91052 and 91055, for 94973
91050	1081	Shuttle Race Cap for 94862
91051	1055	Shuttle Race Cap Pin (short) for 91049
91052	1055	Shuttle Race Cap Pin (long) for 91049
91053	1081	Shuttle Race Cap Spring for 94862
91054	1055	Shuttle Race Loop Spreader for 94973
91055	1055	Shuttle Race Position Pin for 91049
91057	1058	Shuttle Race Slide (back) for 45K87 Machine
91058	1058	Shuttle Race Slide (front) for 91060
91059	1058	Shuttle Race Slide (front) Spring for 91060
91060	—	Shuttle Race Slide 91058, with 91059 and two 337d, for 45K87 Machine
(56) + 91151	—	Bed (Cylinder), with 423c and 91442, for 45K57 Machine
91153	1044	Shuttle Race Ring for 45K57, 45K75 and 45K76 Machines
91160	779	Feed Dog Carrier for 45K57 Machine
91161	775	Feed Forked Connection for 45K57 Machine
*91162	—	Feed Rock Shaft for 91163 756
91163	775	Feed Rock Shaft 91162, with 91165 and 91166, for 91585 756
91165	1750	Feed Rock Shaft Carrier Slide, with 1259c, for 91163 756
91166	1057	Feed Rock Shaft Carrier Slide Steady Pin for 91163 756
91171	775	Oscillating Shuttle Shaft for 45K57 Machine
91172	1750	Oscillating Shuttle Shaft Crank, with 453c and 1850, for 45K57 Machine
91202	1040	Oscillating Shuttle Shaft for 45K75 and 45K76 Machines
91233	776	Face Plate for 91234

+ For Two-Tone Machines the finish of these parts is Grey Metallic (Colour Code No. 728). (56)

No.	Plate	
91234	—	Face Plate, complete, Nos. SS50f, 219f, 233d, 446c, 82449, 82450, 82455, 82502, 82503, 82525, 82551, 91233 and 94825 for 45K57 Machine
91238	—	Lifting Presser Plunger Yoke for 91239
(56) + 91239	779	Lifting Presser Plunger Yoke 91238, with three 149f, for 45K57 Machine
91240	1751	Needle Bar Connection Link
91241	1750	Oil Hole Plug (wood, large)
91242	1750	Oil Hole Plug (wood, medium)
91243	1750	Oil Hole Plug (wood, small)
91248	779	Presser Bar Spring
91249	1751	Presser Foot for 45K57 and 45K87 Machines
91257	1751	Thread Take-up Lever, with 9219, for 91258
91258	—	Thread Take-up Lever 91257, with RR24 and 1519e, for 45K57, 45K75 and 45K76 Machines
91260	1749	Throat Plate for Darning, for 45K57 Machine
91261	—	Work Plate for 45K57 Machine
91294	1082	Driving Attachment Balance Wheel Friction Pulley Centre Bearing for 91723
91296	1061	Driving Attachment Starting Lever for 91299
91297	1061	Driving Attachment Starting Lever Bracket for 91299
91298	1057	Driving Attachment Starting Lever Bracket Hinge Pin for 91299
91299	1061	Driving Attachment Starting Lever, Nos. 91296 to 91298 and three wood screws 1 1/4" No. 15, for 91460
91302	1082	Driving Attachment Lever Bracket for 91722 and 95152
91303	1082	Driving Attachment Lever Centre Plug (wood) for 91722
91306	1057	Driving Attachment Lever Friction Pad (leather) for 91721
91307	779	Driving Attachment Lever Spring for 91722
91315	777	Shuttle Race Cap Spring for 45K57, 45K75 and 45K76 Machines
91409	1750	Shuttle Race Cover for 45K57 Machine
91438	1750	Presser Bar Lifter for 45K57, 45K75 and 45K76 Machines
91441	779	Needle Bar Bushing for 91444, 94810, 94853 and 95154
91442	1769	Oscillating Shuttle Shaft Bushing for 91151
(56) + 91444	—	Arm, with 446c, 450d, 15404, 82499, 82549, 91441 and two 15405, for 45K57 Machine
91446	1751	Roller Wheel 15072, for 91725

+ For Two-Tone Machines the finish of these parts is Grey Metallic (Colour Code No. 728). (56)

Firm the brand: Diamond Machine Corp

No.	Plate	
91453	1061	Foot Lifter Foot Lever Pitman Connecting Hook (7" long) for 91456 and 94843 ...
91454	—	Foot Lifter Foot Lever only, complete, Nos. 17881, 91457 to 91459, 98626 and two wood screws 1" No. 12 for 91455 ...
91455	—	Foot Lifter Foot Lever, complete, Nos. 17880 and 91454 for 91456 and 94843 ...
91456	—	Foot Lifter, complete, Nos. 694d, 91453, 91455 and 91716 for 45K57 and 45K87 Machines ...
91457	1061	Foot Lifter Foot Lever, with 176c, for 91454
91458	1061	Foot Lifter Foot Lever Extension for 91454
91459	1061	Foot Lifter Foot Lever Bracket for 91454 ...
91460	—	Driving Attachment Starting Lever and Pitman, complete, Nos. 17880 and 91299 for 91724 and 95153 ...
91475	1082	Driving Attachment Balance Wheel Friction Pulley Ring (cardboard) for 91614 ...
91565	—	Feed Rock Shaft 91163, with 98674, for 45K57 Machine ...
91613	1061	Balance Wheel (two-speeds), with two 434c, for 45K87 Machine ...
91614	1082	Driving Attachment Balance Wheel, with 434c, 451c, 91475 and four 402e, for 91724
91615	1040	Arm Shaft ...
91651	1749	Presser Bar (with squared end) for 45K57 Machine ...
91652	1054	Presser Bar Lifting Bracket, with 446c, for 91711 ...
91690	—	Lifting Presser Plunger for 91691 ...
91691	1056	Lifting Presser Plunger 91690, with 80557 and 80558, for 45K57 Machine ...
91711	—	Presser Bar Lifting Bracket 91652, with 82510 and two 190f, for 45K57 Machine ...
91714	777	Throat Plate for 98680 for Patching, for 45K57 Machine ...
91716	1061	Foot Lifter Arm Lever for 91456 ...
566 † 91718	1040	Bobbin Winder Bracket for 91720 ...
566 † 91719	1751	Bobbin Winder Frame for 91725 ...
91720	—	Bobbin Winder (friction), complete, Nos. 32d, 161d, 82537, 82538, 91718 and 91725 for Fast Wheel and S.D.A. Machines ...
91721	1082	Driving Attachment Lever, with 7958 and

† For Two-Tone Machines the finish of these parts is Grey Metallic (Colour Code No. 728) (566)

No.	Plate	
91722	—	Driving Attachment Lever, complete, Nos. NN28c, 161c, 427c, 693d, 1508e, 91302, 91303, 91307, 91721 and two SS38c for 91724 ...
91723	1082	Driving Attachment Balance Wheel Friction Pulley (two-speeds), with 448c and 91294, for 91724 ...
91724	—	Driving Attachment, complete, Nos. 84275, 91460, 91614, 91722 and 91723 ...
91725	1040	Bobbin Winder Frame, complete, Nos. 333r, 5960, 5961, 5963, 91446 and 91719 for 91720 ...
91753	1043	Shuttle Race (steel, hardened) for 45K57, 45K75 and 45K76 Machines ...
94801	775	Crank Connecting Rod, with 94802, 94872 and two 158c, for 45K57, 45K75 and 45K76 Machines ...
*94802	—	Crank Connecting Rod Cap for 94801 and 98664 ...
(566) † 94810	—	Arm, with 446c, 450c, 15404, 82449, 82549, 91441 and two 15405, for 45K76 Machines
" † 94811	—	Bed (Cylinder), with 423c and 98633, for 45K75 and 45K76 Machines ...
" † 94812	1040	Face Plate for 94813 ...
94813	—	Face Plate, complete, Nos. 219f, 233d, 446c, 82449, 82450, 82455, 82502, 82503, 82525, 82551, 94812, 94825, 94836 and two SS50f, for 45K75 and 45K76 Machines ...
94814	1041	Lifting Presser Plunger for 94820 ...
94815	1041	Lifting Presser Plunger Pin for 94820 ...
94816	1041	Lifting Presser Plunger Plug for 94820 ...
94817	1041	Lifting Presser Plunger Buffer (rubber) for 94820 ...
94818	1041	Lifting Presser Plunger Roller for 94820 ...
94819	1041	Lifting Presser Plunger Roller Pin for 94820
94820	—	Lifting Presser Plunger, complete, Nos. 94814 to 94816, 94818, 94819 and five 94817 for 45K75, 45K76 and 45K87 Machines...
94821	1041	Lifting Presser Plunger Bracket, with two 1186f, for 45K75 and 45K76 Machines ...
94822	1041	Lifting Presser Plunger Bracket Spring for 45K75, 45K76 and 45K87 Machines ...
94823	1041	Oil Hole Plug (wood, small), for Plunger ...
94824	1040	Presser Bar (with squared end) for 45K75, 45K76 and 45K87 Machines ...
94825	1041	Thread Take-up Spring Regulator for 91234, 91212 and 94050 ...

† For Two-Tone Machines the finish of these parts is Grey Metallic (Colour Code No. 728). (566)

No.	Plate	
94826	1041	Presser Bar Cushion Spring for 45K75 and 45K76 Machines
94827	1041	Presser Bar Lifting Bracket, with two 1186d, for 45K75 and 45K76 Machines ...
94828	1041	Presser Bar Lifting Bracket Sleeve for 45K75 and 45K76 Machines
94829	1041	Presser Bar Lifting Bracket Tension Release for 45K75 and 45K76 Machines ...
94830	1041	Presser Foot for 45K75 and 45K76 Machines
94836	1041	Tension Thread Guide for 94813
94837	1749	Thread Take-up Cam, with SS320c and SS370c, for 94839 and 94864
94838	1043	Thread Take-up Cam Lifting Cam for 94839
94839	1043	Thread Take-up Cam 94837, with 94838 and three 191c, for 45K57, 45K75 and 45K76 Machines
94840	1044	Throat Plate for 45K75 and 45K76 Machines
94841	—	Work Plate for 45K75 and 45K76 Machines
94842	1061	Foot Lifter Arm Lever for 94843
94843	—	Foot Lifter, complete, Nos. 694d, 91453, 91455 and 94842, for 45K75 and 45K76 Machines
*94853	—	Arm, with 446c, 450c, 15404, 82499, 82549, 91441 and two 15405, for 45K87 Machine
94854	1057	Arm Cover for 45K87 Machine
94855	—	Face Plate for 94856
94856	—	Face Plate, complete, Nos. SS50f, 219f, 233d, 446c, 82449, 82450, 82455, 82502, 82503, 82525, 82551, 94825 and 94855 for 45K87 Machine
94857	1054	Lifting Presser Plunger Bracket, with two 1186f, for 45K87 Machine
94858	1056	Lifting Presser Dash Pot for 45K87 Machine
94859	1056	Lifting Presser Dash Pot Plunger for 45K87 Machine
94860	1054	Presser Bar Lifter for 45K87 Machine
94861	1054	Presser Bar Lifting Bracket, with two 1186d, for 45K87 Machine
94862	—	Shuttle Race (adjustable), complete, Nos. 41d, 91050, 91053 and 94973, for 45K87 Machine
94863	1749	Thread Take-up Cam Lifting Cam for 94864
94864	1749	Thread Take-up Cam 94837, with 94863 and three 191c, for 45K87 Machine
94865	1055	Thread Take-up Lever, with 9219, for 94866
94866	—	Thread Take-up Lever 94865, with RR24 and 1519e, for 45K87 Machine

No.	Plate	
94867	1056	Throat Plate for 45K87 Machine
94872	1743	Crank Connecting Rod Cap Oil Pad for 94801 and 98664
94972	1489	Oscillating Rock Shaft Steel Plate (top) for 98628 and 98630 ... (Obsolete)
94973	—	Shuttle Race 91049, with 91054 and two 401f, for 94862
95093	1696	Shuttle Bobbin for 98624
95094	1696	Shuttle Cylinder for 98624
95125	1401	Thread Unwinder, complete, Nos. 27623, 27627, 84148 and two wood screws 1 1/4" No. 10
95126	1401	Thread Unwinder Spool Weight, 4" diam., for 95125 (only supplied when specified on order)
95141	1466	Balance Wheel for 95143
95142	1466	Balance Wheel Loose Pulley for 95143
95143	—	Balance Wheel, complete, Nos. 95141 and 95142, for fast and loose pulley, for 98625
95145	1465	Clamp Stop Motion Clamp Washer for 95190 and 98625
95146	1465	Clamp Stop Motion Flanged Bushing, with two 434c, for 95190 and 98625
95148	1057	Driving Attachment Lever Belt Shifter for 95152
95149	1057	Driving Attachment Lever Belt Shifter Rod for 95152
95150	1057	Driving Attachment Lever Spring for 95152
95152	—	Driving Attachment Lever, complete, Nos. NN28c, 693d, 727c, 1623c, 7958, 91302, 95149, 95150, 98507, 98643, two each SS38c, 190d, 95148 and three 363c, for 95153
95153	—	Driving Attachment, complete, Nos. 84275, 91460, 95152 and 98625 for 45K75 Machine
*95154	—	Arm, with 446c, 450c, 15404, 82499, 82549, 91441 and two 15405, for 45K75 Machine
95189	1465	Balance Wheel for 95190
95190	—	Clamp Stop Motion, complete, Nos. 248f, SS463d, 95145, 95146 and 95189 for 45K57 and 45K76 Machines
95197	1487	Bobbin Winder Stop Latch for 95198
95198	1488	Bobbin Winder, Nos. 35d, 1620j, 27302, 27303, 27540, 27541, 50356b, 95197, 98673 and two wood screws 1" No. 7 R.H. for 95199

No.	Plate	
95199	—	Bobbin Winder (Swinging Automatic, right hand), complete, Nos. 27308 and 95198 for 95093
98507	2354	Driving Attachment Lever Friction Pad (leather) for 95152
98601	1489	Presser Bar Cushion Spring for 45K87 Machine
98602	1696	Shuttle Tension Spring for 98624
98606	2354	Bed Oil Pad for 45K75 and 45K76 Machines
98607	1743	Shuttle Driver for 45K87 Machine

No. 98607 can only be used with No. 98621 and not with old style Shuttles.

98609	1743	Shuttle Driver and Feed Raising Cam for 98611
98610	1743	Shuttle Driver Thread Guard for 98611
98611	1743	Shuttle Driver and Feed Raising Cam, complete, Nos. 98609, 98610 and two 223d, for 45K57, 45K75 and 45K76 Machines

No. 98611 can only be used with No. 98621 and not with old style Shuttles.

98614	1743	Crank Connecting Rod Hinge Stud Cotter Pin for 98640 and 98641
98621	1696	Shuttle Frame for 98624
98624	1696	Shuttle (Cylinder), 2½" diam., complete, Nos. SS377f, SS574d, 91042, 91043, 95093, 95094, 98602 and 98621

No. 98624 can only be used with Nos. 98607 and 98611 and not with old style Shuttle Drivers.

98625	—	Clamp Stop Motion, complete, Nos. 248f, SS463d, 95143, 95145 and 95146, for 95153
98626	1061	Foot Lifter Foot Lever Spring for 91454
98627	1743	Crank Connecting Rod Hinge Stud for 98640 and 98641
98628	1743	Oscillating Rock Shaft, with 91025, 94972 and two 91026, for 45K87 Machine (Obsolete)
98630	1743	Oscillating Rock Shaft, with 91025, 94972 and two 91026, for 45K57, 45K75 and 45K76 Machines ... (Obsolete)
98633	1769	Oscillating Shuttle Shaft Bushing for 94811

No.	Plate	
98635	2354	Oscillating Shuttle Shaft Crank, with RR62, 453c and 1518c, for 45K75, 45K76 and 45K87 Machines
98636	1769	Oscillating Rock Shaft Steel Plate (bottom) for 98638 and 98639
98637	1769	Oscillating Rock Shaft Steel Plate (top) for 98638 and 98639
98638	1769	Oscillating Rock Shaft, with 98636, 98637, two each SS537e and 1698c, for 98640
98639	1769	Oscillating Rock Shaft, with 98636, 98637, two each SS537e and 1698c, for 98641
98640	—	Oscillating Rock Shaft, complete, Nos. 1668c, 98614, 98627 and 98638, for 45K87 Machine
98641	—	Oscillating Rock Shaft, complete, Nos. 1668c, 98614, 98627 and 98639, for 45K57, 45K75 and 45K76 Machines
98642	779	Oscillating Rock Shaft Hinge Pin
98643	1466	Driving Attachment Lever for 95152
98664	776	Crank Connecting Rod, with 94802, 94872 and two 168e, for 45K87 Machine
98673	1487	Bobbin Winder Spindle with 15072, for 95198
98674	1054	Feed Rock Shaft Crank with 156f and SS517c, for 91565
98680	2354	Feed Dog for 45K57 Machine

From the library of Diamond Needle Co.

NUMERICAL LIST OF PARTS

No. Plate

1 1
1 1

NUMERICAL LIST OF PARTS

No. Plate

1:162

- 109779(805) -- Crank Connecting Rod Cap Screw for 94801 and 98664
- 109779(805) — Needle Bar Connection Clamping Screw for 91022

1 1
1 1

1 1
1 1

From the library of: Diamond Needle Corp.

NUMERICAL LIST OF PARTS

No.	Plate		
120342	1600	Oiler	(Accessories)
120378	1489	Screw Driver (Shuttle Tension)	Accessories
		<i>No. Cancelled, order 161295</i>	
7/60	161295	—	Screw Driver (shuttle tension) (Accessories)

Name	Plate
J. Conklyn	9/51
C. MacDonall	2/50
J. Redziak	7/60
Emily Brady	6/59
Mary Anavich	10/62



From the library of: Diamond Needle Corp